

Service Manual
**(PRF32405XW/
PRF32406XS)**

CONTENTS

PARTS IDENTIFICATION	1
REFRIGERATION CIRCUIT	2
CIRCUIT DIAGRAM.....	3
SAFETY PRECAUTIONS	4-5
USING INTRODUCTION	6-8
DISASSEMBLY COMMON PARTS OF FREEZER	9-18
◆ DOOR REVERSAL INSTRUCTIONS	
◆ CARE & MAINTENANCE	
◆ Checking the compressor and replacing PTC and Overload protector	
◆ Checking the thermostat and replacing thermostat	
EXPLODED VIEW	19
TROUBLESHOOTING.....	20

FEATURES

1. Freezer Compartment with Door
2. Thermostat Dial and Push Button Defrost
3. Drip Tray
4. Plastic Coated Shelves
5. Magnetic Gasket: Tight fitting door seal keeps all the cooling power locked inside.
6. CANSTOR: Holds 355ml cans of pop, juice, or beer.
7. Bottle Rack: For tall, small and medium cans or jars.
8. Leveling Leg: Adjust so the unit is level.

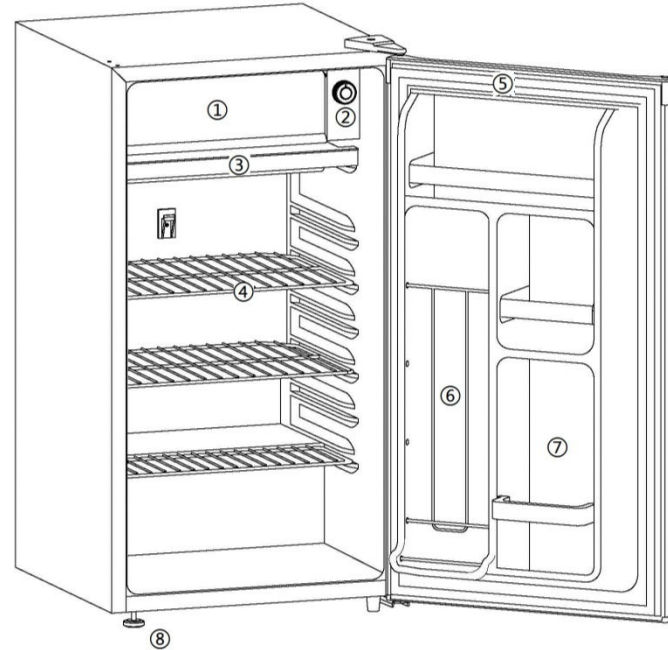

Basic refrigeration schematic

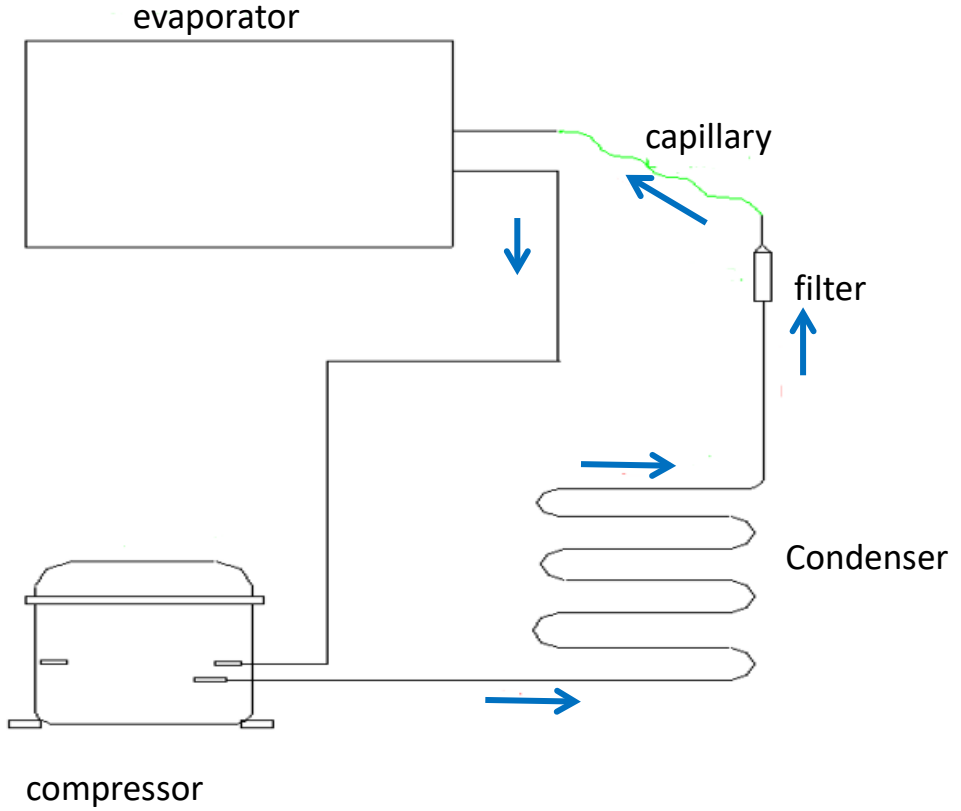

CIRCUIT DIAGRAM

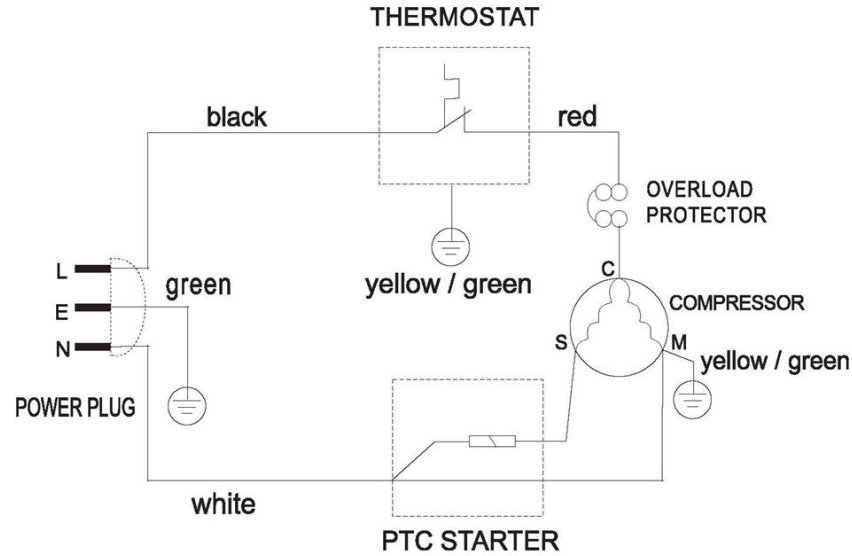

SAFETY REQUIREMENTS

DANGER: Risk of fire or explosion. Flammable refrigerant used. Do not puncture refrigerant tubing.

- Do not use mechanical devices to defrost refrigerator.
- Ensure that servicing is done by factory authorized service personnel, to minimize product damage or safety issues.
- If the power supply cord is damaged, it must be replaced by the manufacturer, its service agent or similar qualified person in order to avoid hazard.
- Consult repair manual or owner's guide before attempting to service this product. All safety precautions must be followed.
- Dispose of properly in accordance with federal or local regulations.
- Follow handling instructions carefully.
- Do not store explosive substances such as aerosol cans with a flammable propellant in this appliance.

WARNING: Keep ventilation openings, in the appliance enclosure or in the built-in structure, clear of obstruction.

WARNING: Do not use mechanical devices or other means to accelerate the defrosting process, other than those recommended by the manufacturer.

WARNING: Do not damage the refrigerant circuit.

WARNING: Do not use electrical appliances inside the food storage compartments of the appliance, unless they are of the type recommended by the manufacturer.

CAUTION: Children should be supervised to ensure that they do not play with the appliance.

DANGER: Risk of child entrapment. Before throwing away an old appliance:

- Remove the door or lid.
- Leave shelves in place so that children may not easily climb inside.

DANGER: Do not add a lock to the door or lid. This can cause child entrapment and harm.

SAFETY REQUIREMENTS

This appliance is not intended for use by persons (including children) whose physical, sensory or mental capabilities may be different or reduced, or who lack experience or knowledge, unless such persons receive supervision or training to operate the appliance by a person responsible for their safety.

This appliance is intended to be used in household and similar applications such as:

- Staff kitchen areas in shops, offices and other working environments;
- Farm houses and by clients in hotels, motels and other residential type environments;
- Bed and breakfast type environments;
- Catering and similar non-retail applications.

GROUNDING INSTRUCTIONS

This appliance must be grounded. Grounding reduces the risk of electrical shock by providing an escape wire for the electrical current. This appliance has a cord that has a grounding wire with a 3-prong plug. The power cord must be plugged into an outlet that is properly grounded. If the outlet is a 2-prong wall outlet, it must be replaced with a properly grounded 3-prong wall outlet. The serial rating plate indicates the voltage and frequency the appliance is designed for.

WARNING - Improper use of the grounding plug can result in a risk of electric shock. Consult a qualified electrician or service agent if the grounding instructions are not completely understood, or if doubt exists as to whether the appliance is properly grounded.

Do not connect your appliance to extension cords or together with another appliance in the same wall outlet. Do not splice the power cord. Do not under any circumstances cut or remove the third ground prong from the power cord. Do not use extension cords or ungrounded (two prongs) adapters.

LOCATION

- Two people should be used when moving the appliance.
- Remove interior and exterior packaging prior to installation. Wipe the outside of the appliance with a soft, dry cloth and the inside with a lukewarm wet cloth.
- Place the appliance on a floor that is strong enough to support it when it is fully loaded.
- Do not place the appliance in direct sunlight or near sources of heat, such as a stove or heater, as this can increase electrical consumption. Extreme cold ambient temperatures may also cause the appliance to perform improperly.
- Do not use the appliance near water, for example in a wet basement or near a sink.
- This appliance is intended for household use only. It is not designed for outside installation, including anywhere that is not temperature controlled (garages, porches, vehicles, etc.).
- Before connecting the appliance to a power source, let it stand upright for approximately 6 hours. This will reduce the possibility of a malfunction in the cooling system from handling during transportation.
- This appliance is 44.9 cm (17.7 inches) wide by 83.3 cm (32.8 inches) high by 47 cm (18.5 inches) deep.
- Allow 12.7 cm (5 inches) of space between the back, sides and top of the appliance and all adjacent walls.
- This appliance is intended for free-standing installation only and is not intended to be built into a cabinet or counter. Building in this appliance can cause it to malfunction.

IMPORTANT

Ensure that the door is fully closed when the appliance is in operation. Failure to fully close the door can lead to excessive condensation and potential water damage to flooring under the appliance.

TEMPERATURE SELECTION

The temperature of the appliance can be adjusted by turning the thermostat dial.

The thicker, darker part of the blue line is the coldest setting.

The thinner, lighter part of the blue line is the warmest setting.

The “O” position will turn off the cooling function.

Internal temperature of the appliance can vary based on ambient temperature, the quantity of items stored and how frequently the door is opened.



OUTER DIMENSIONS

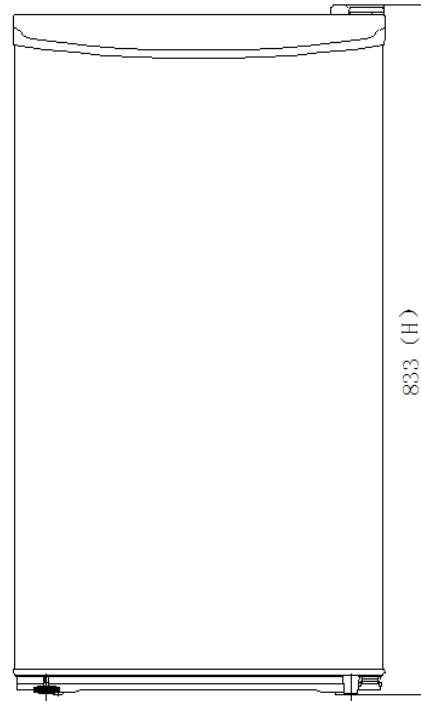
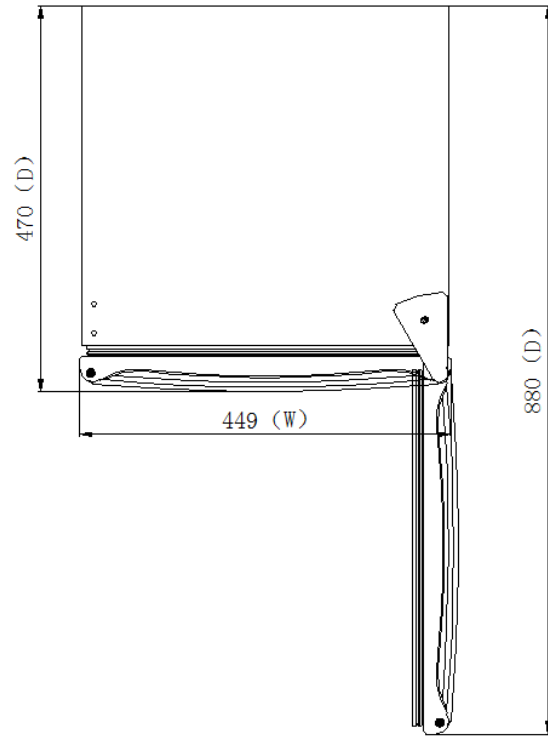

DOOR REVERSAL INSTRUCTIONS

If the appliance is placed on its back or side for any length of time during this process, it must be allowed to remain upright for 6 hours before plugging it in to avoid damage to the internal components.

1. Remove the hinge cover and the upper hinge. Remove the hinge hole covers from the top left side of the cabinet. Remove the door from the cabinet.

2. Remove the hinge hole cover from the top left side of the door and place it in the hinge hole on the top right side of the door.

3. Remove the adjustable foot from the bottom left side of the cabinet and remove the solid foot and lower hinge from the bottom right side of the cabinet. Install the lower hinge and solid foot on the bottom left side of the cabinet and install the adjustable foot on the bottom right side of the cabinet.

4. Place the door on the cabinet and install the upper hinge on the top left side of the cabinet. Before tightening the screws in the upper hinge, ensure that the top of the door is level with the top of the cabinet and that the rubber gasket is making a good seal with the cabinet all the way around. Install the hinge cover over the hinge and install the hinge hole covers in the screw holes on the top right side of the cabinet.

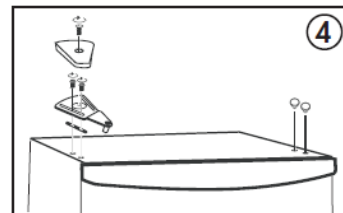
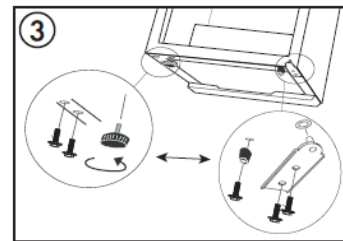
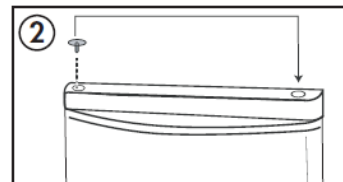
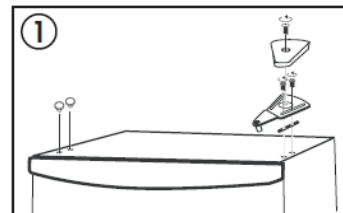

CARE & MAINTENANCE

CLEANING

Ensure the appliance is unplugged before cleaning.

- To clean the inside of the appliance, use a soft cloth and a solution of a tablespoon of baking soda to one quart of water or a mild soap solution or some mild detergent.
- Wash removable shelves in a mild detergent solution, then dry and wipe with a soft cloth.
- Clean the outside with a soft, damp cloth and some mild detergent.
- It is important to keep the area clean where the door seals against the cabinet. Clean this area with a soapy cloth. Rinse with a damp cloth and let dry.

Note: Do not use cleaners containing ammonia or alcohol on the appliance. Ammonia or alcohol can damage the appearance of the appliance. Never use any commercial or abrasive cleaners or sharp objects on any part of the appliance.

CARE & MAINTENANCE

POWER FAILURE

Most power failures are corrected within a few hours and should not affect the temperature of your appliance if you minimize the number of times the door is opened. If the power is going to be off for a longer period of time, take the proper steps to protect your contents.

Note: Wait 3 to 5 minutes before attempting to restart the refrigerator if operation has been interrupted.

VACATION

- Short vacations: Leave the appliance operating during vacations of less than three weeks.
- Long vacations: If the appliance will not be used for several months, remove all items and turn off the appliance. Clean and dry the interior thoroughly. To prevent odor and mold growth, leave the door open slightly, blocking it open if necessary.

CARE & MAINTENANCE

MOVING

- Make sure the appliance is empty.
- Secure the shelves with tape.
- Secure the door with tape.
- Turn the adjustable foot up to the base to avoid damage.
- Protect the outside of the appliance with a blanket or similar item.
- Be sure the appliance stays in the upright position during transportation.
- If the appliance is placed on its back or side during transportation, upon reaching the destination, allow it to remain upright for 6 hours before plugging in to avoid damage to internal components.

DISPOSAL

This appliance may not be treated as regular household waste, it should be taken to the appropriate waste collection point for recycling of electrical components. For information on local waste collection points, contact your local wasteremoval agency or government office.

Checking the compressor

After the compressor is powered on separately, the compressor does not start and exhaust.

Use a multi-meter to test the resistance between C & M, C&S and S&M :

Normal range of C&M : About $8.76\sim 11.85\Omega$

Normal range of C&S : About $7.48\sim 10.12\Omega$

Normal range of S&M : About $16.24\sim 21.97\Omega$

If the test result is not in this range then it means the inner coil has some problem and the compressor cannot work properly.

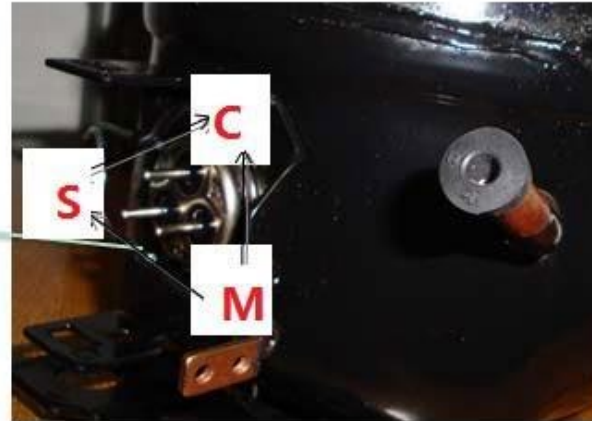

Checking the compressor accessory

Remove the combined PTC starter and overload protector



model : ZHB54-120P4.7 A

Checking the compressor accessory

Compressor Protector test — —

Use a multi-meter to test the resistance between the two terminals as the pic show :

If there show 000 or almost 0 then it is OK.

If there is no response then it is broken.

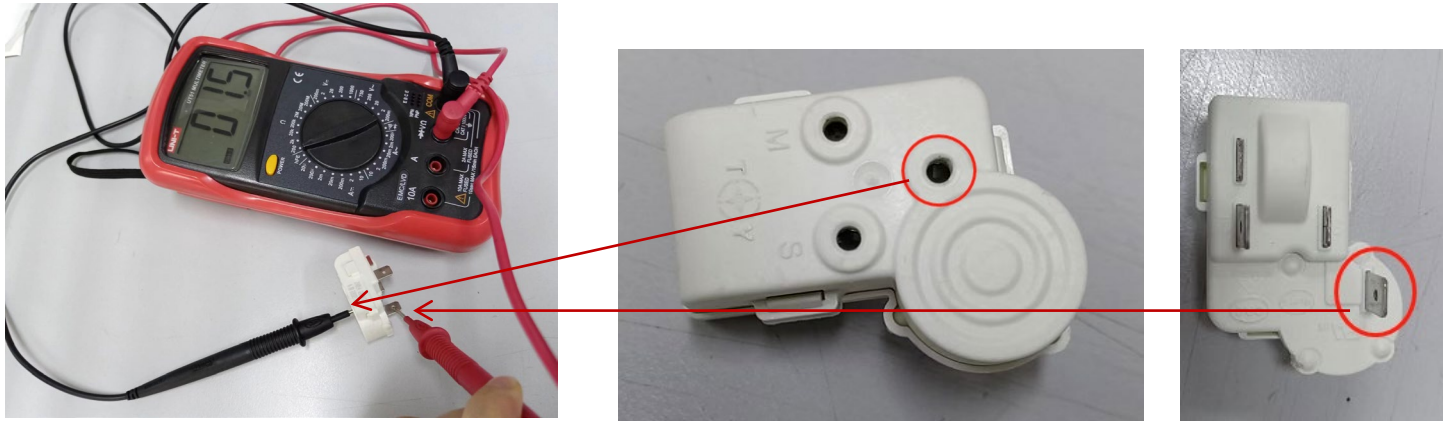

model : ZHB54-120P4.7 A

Checking the compressor accessory

Compressor PTC starter test — —

Use a multi-meter to test the resistance between the two terminals as the pic show

If there show the number is between about 3.7-5.7 then it is OK.

If there show 000 or no response then it is broken.

After the replacement of the combined PTC starter and overload protector,
the compressor still does not start.

If there is no exhaust, the compressor is fault.



model : ZHB54-120P4.7 A

The instruction of replacing PTC and Overload protector

- 1.Remove the fastening screws
- 2.Remove the Compressor Wire Clamp Screw and Compressor Wire Clamp
- 3.Remove the cover
- 4.Replace the combined PTC starter and overload protector

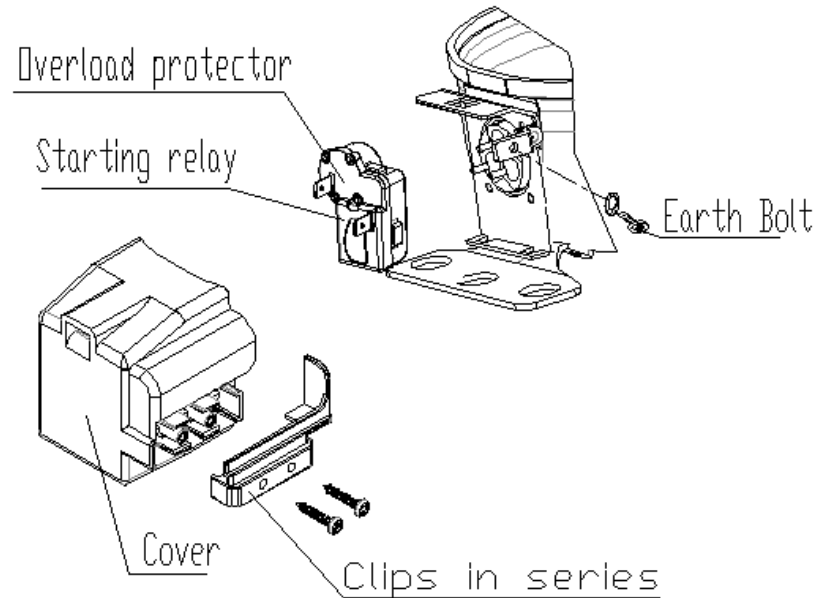

Checking the thermostat

Use a multi-meter to check the C-L terminal is on or off.

The instruction of replacing thermostat

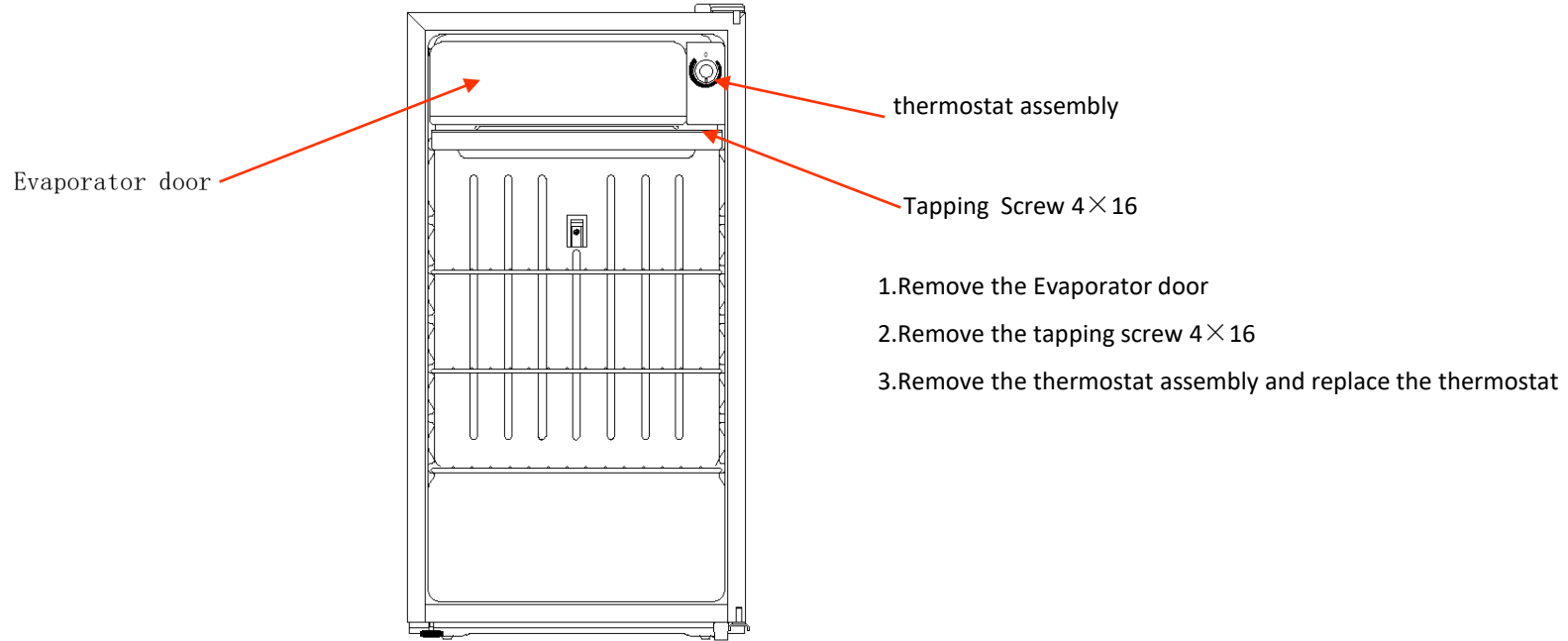

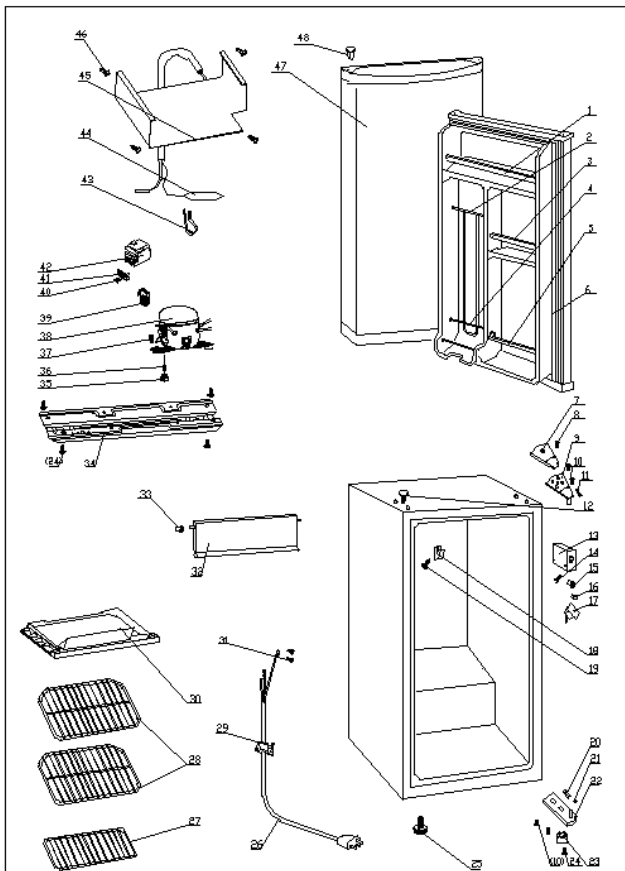

NO	Appellation	QTY	NO	Appellation	QTY
1	Door Upper Shelf Bar	1	36	Compressor Sleeve	4
2	Can Support(Chute Bar)	6	37	Compressor Screw	4
3	Door Middle Shelf Bar	2	38	Compressor	1
4	Shelf Bar	1	39	PTC & Overload Protector Combination	1
5	Curve Shelf	1	40	Tapping Screw(ST3.5*19)	2
6	Door Gasket	1	41	Clamp	1
7	Hinge Cover	1	42	PTC Cover	1
8	screw M4X6	1	43	Filter holder	1
9	Upper Hinge	1	44	Filter	1
10	Screw Assy(M5*16, big washer)	6	45	Evaporator	1
11	Upper Hinge Rubber Washer	1	46	Tapping Screw(ST4.2*13)	4
12	Hinge Plug	2	47	Door Assy	1
13	Thermostat Cover	1	48	Hinge Plug	1
14	Thermostat Cover Screw	1			
15	Thermostat Knob	1			
16	Defrost Button	1			
17	Thermostat	1			
18	Limit block	1			
19	Tapping screw	1			
20	Bottom Hinge Rubber Washer	1			
21	Door Spindle Washer	1			
22	Bottom Hinge	1			
23	Foot	1			
24	Screw Component (M6x14)	5			
25	Adjustable Foot	1			
26	Power Supply Cord	1			
27	Half Wire Shelf	1			
28	Wire Shelf	1			
29	ST Screw(4x12,end-milling)	1			
30	Drip Tray	1			
31	818 Screw M4x8(Copper)	2			
32	Evaporator Door	1			
33	Evaporator Door Bushing	1			
34	Compressor Support	1			
35	Compressor Rubber Washer	4			

PROBLEM	POSSIBLE CAUSE
No power	<ul style="list-style-type: none">• A fuse may be blown or the circuit breaker tripped• Plug not fully inserted into the wall outlet
Internal temperature not cold enough	<ul style="list-style-type: none">• Temperature setting is too warm• Door is not shut properly or opened excessively• Recently added a large quantity of warm food to the cabinet• Close proximity to heat source or direct sunlight• Ambient temperature or humidity is very high
Appliance runs continuously	<ul style="list-style-type: none">• Temperature setting is too cold• Door not shut properly or opened excessively• Recently added a large quantity of warm food to the cabinet• Close proximity to heat source or direct sunlight• Ambient temperature or humidity is very high