



SERVICE MANUAL

AUTOMATIC WASHING MACHINE

PWMA602PM

PWMA1002PM

PWMA1202PM

TABLE OF CONTENTS

1.SAFETY PRECAUTION	2
1.1 Safety Precaution.....	2
2.2 Waring.....	2
2.TROUBLESHOOTING	3
2.1 Malfuction and solution.....	3
2.2 Fault tree.....	4
2.3 Not turn or one-way turn when wash.....	5
2.4 Abnormal downtime midway.....	6
2.5 Abnormal noise and big vibration.....	7
2.6 No bilging and bilging intermittent.....	8
2.7 Water does not stop.....	9
2.8 No drainage.....	10
2.9 No spinning.....	11
2.10 Leaking.....	12
2.11 Oily shape dirt adherent.....	13
2.12 Anomaly alarm.....	14
3. UNPACKING WAYS OF MAIN PARTS	15
3.1 Product disassembly precautions and steps.....	15
4. CIRCUIT DIAGRAM	21
4.1 The wiring picture.....	21
4.2 The electrical principle picture.....	21
5.EXPLORED VIEW & LIST OF PARTS	22

1. SAFETY PRECAUTION

1.1 Safety Precaution

- To prevent injury to the user or other people and property damage, the following instructions must be followed.
- Incorrect operation due to ignoring instruction will cause harm or damage.
- Before service unit, be sure to read this service manual at first.

1.2 Warning

$\frac{3}{4}$ Installation

- **Do not use a defective or underrated circuit breaker. Use this appliance on a dedicated circuit.**
There is risk of fire or electric shock.
- **For electrical work, contact the dealer, seller, a qualified electrician, or an Authorized service center.**
Do not disassemble or repair the product, there is risk of fire or electric shock.
- **Always ground the product.**
There is risk of fire or electric shock.
- **Install the panel and the cover of control box securely.**
There is risk of fire of electric shock.
- **Always install a dedicated circuit and breaker.**
Improper wiring or installation may cause fore or electric shock.
- **Use the correctly rated breaker of fuse.**
There is risk of fire or electric shock.
- **Do not modify or extend the power cable.**
There is risk of fire or electric shock.
- **Do not install, remove, or reinstall the unit by yourself (customer).**
There is risk of fire, electric shock, explosion, or injury.
- **Be caution when unpacking and installing the product.**
Sharp edges could cause injury, be especially careful of the case edges and the fins on the condenser and evaporator.
- **For installation, always contact the dealer or an Authorized service center.**
There is risk of fire, electric shock, explosion, or injury.
- **Do not install the product on a defective installation stand.**
It may cause injury, accident, or damage to the product.
- **Be sure the installation area does not deteriorate with age.**
If the base collapses, the wash machine could fall with it, causing property damage, product failure, and personal injury.
- **Take care to ensure that power cable could not be pulled out or damaged during operation.**
There is risk of fire or electric shock.
- **Do not place anything on the power cable.**
There is risk of fire or electric shock.
- **Do not plug or unplug the power supply plug during operation.**
There is risk of fire or electric shock.
- **Do not touch (operation) the product with wet hands.**
There is risk of fire or electric shock.
- **Do not place a heater or other appliance near the power cable.**
There is risk of fire and electric shock.
- **Do not allow water to run into electric parts.**
It may cause fire, failure of the product, or electric shock.
- **Do not store or use flammable gas or combustible near the product.**
There is risk of fire or failure of product.
- **Do not use the product in a tightly closed space for a long time.**
Oxygen deficiency could occur.
- **If strange sounds, or small or smoke comes from product. Turn the breaker off or disconnect the power supply cable.**
There is risk of electric shock or fire.
- **Stop operation and close the window in storm or hurricane. If possible, remove the product from the window before the hurricane arrives.**
There is risk of property damage, failure of product, or electric shock.
- **Be caution that water could not enter the product.**
There is risk of fire, electric shock, or product damage.
- **Turn the main power off when cleaning or maintaining the product.**
There is risk of electric shock.
- **When the product is not be used for a long time, disconnect the power supply plug or turn off the breaker.**
There is risk of product damage or failure, or unintended operation.

$\frac{3}{4}$

2.TROUBLESHOOTING

2.1 Malfunction and solution

Symptoms	Daily inspection method
Not running	Is the fuse damaged or do the fuse box contact badly? Do the power cord plug insert normally ? Do you turn on the tap ?
Undrained	Do you put down the drain hose ? Is the drain hose blocked ? Is the drain hose connected normally ?
Not filling	Do you turn on the tap ? Do the water pipe freezes ? Is the inflow pipe /the water inlet valve filter net blocked ?
Don't spinning	Is the washing clothes bias ? Do you put down the drain hose ? Do you cover the door cover ?

2.TROUBLESHOOTING

2.2Fault tree

1.All operation failure

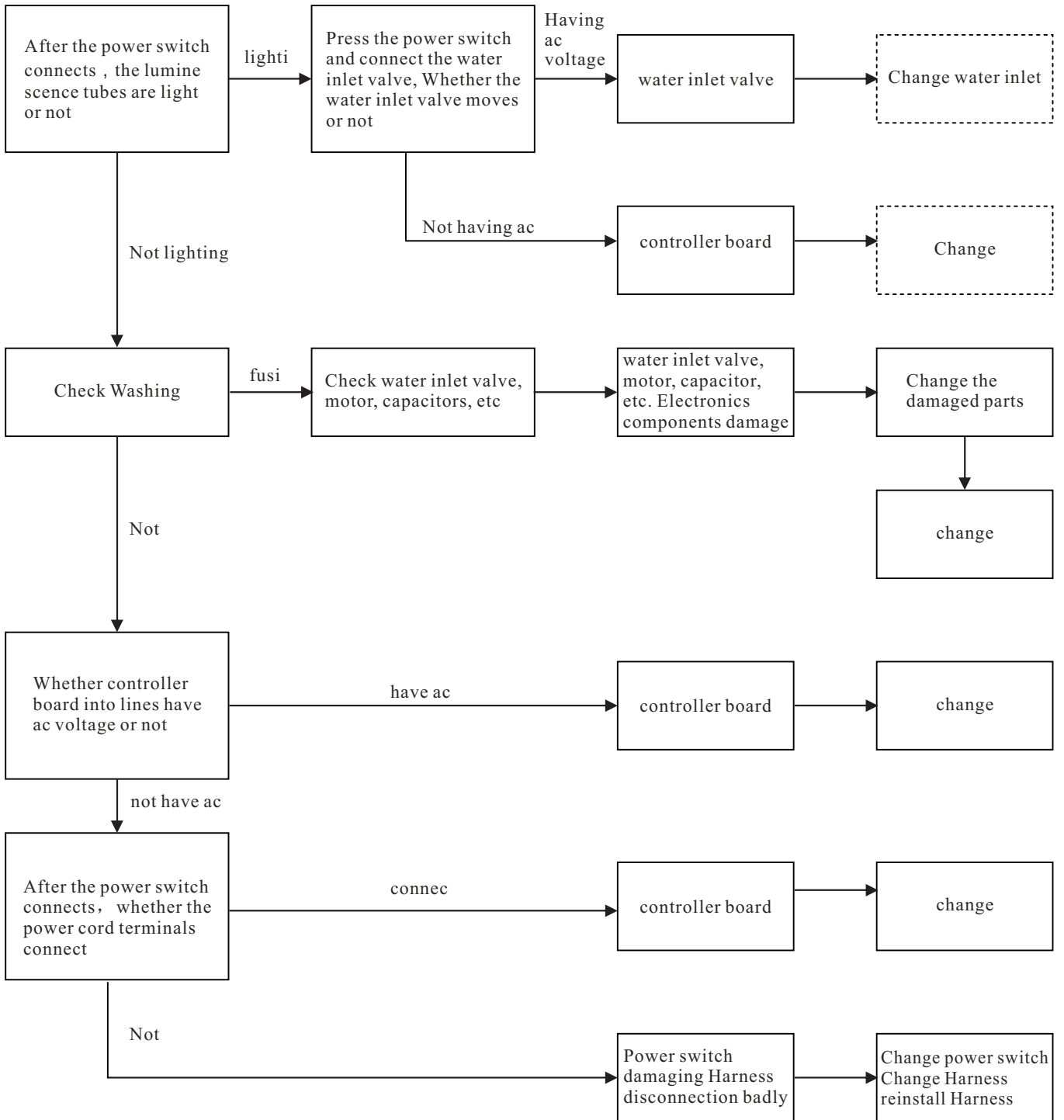

2.TROUBLESHOOTING

2.3 Not turn or one-way turn when wash

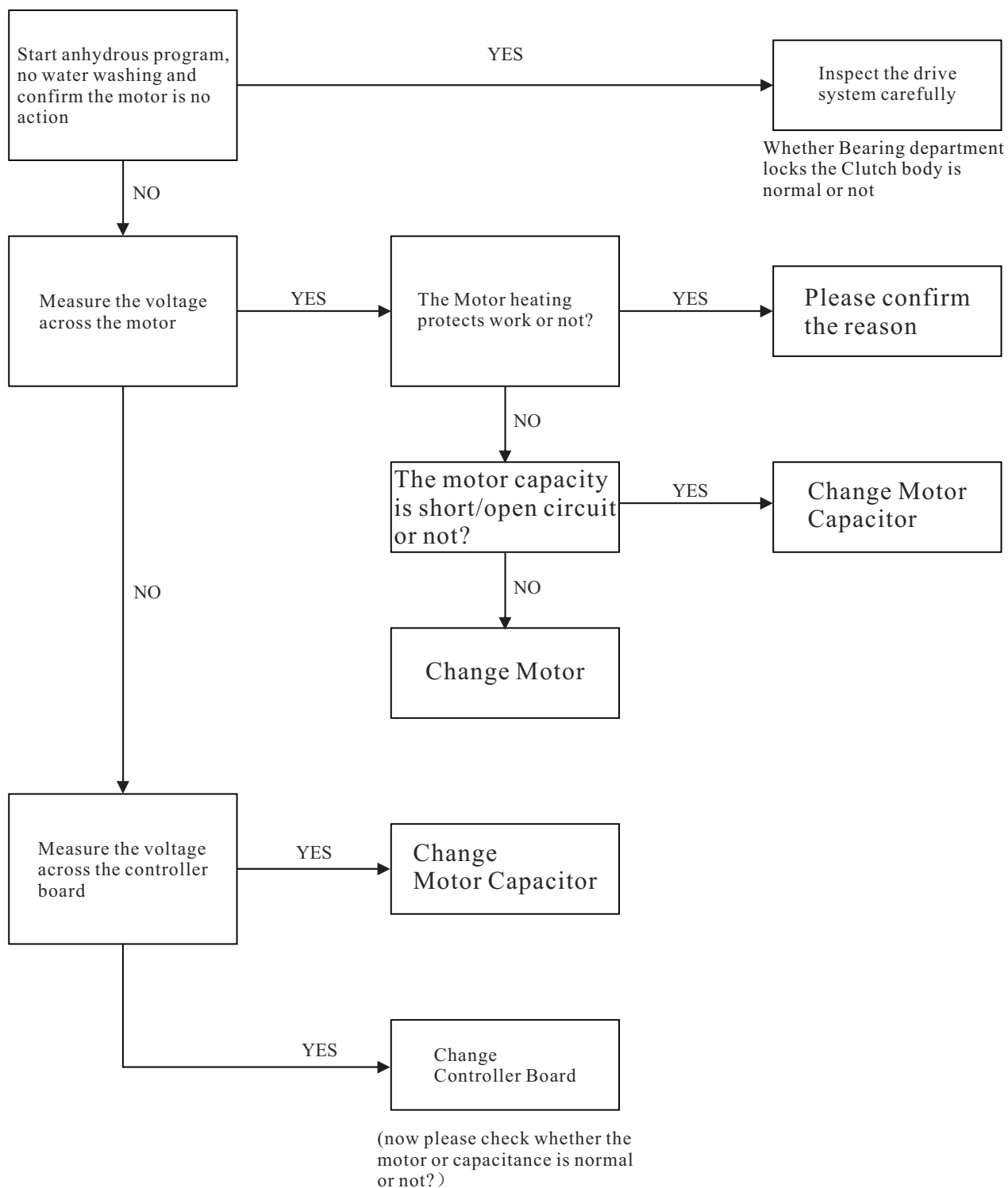

2.TROUBLESHOOTING

2.4 Abnormal downtime Midway

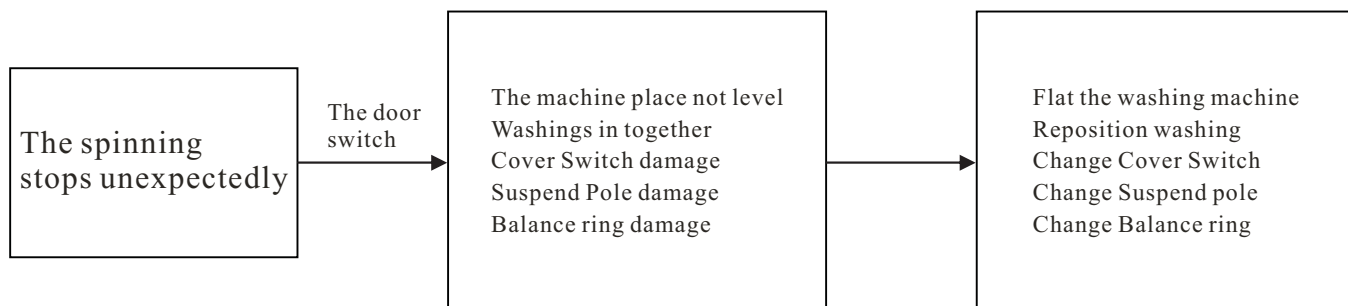
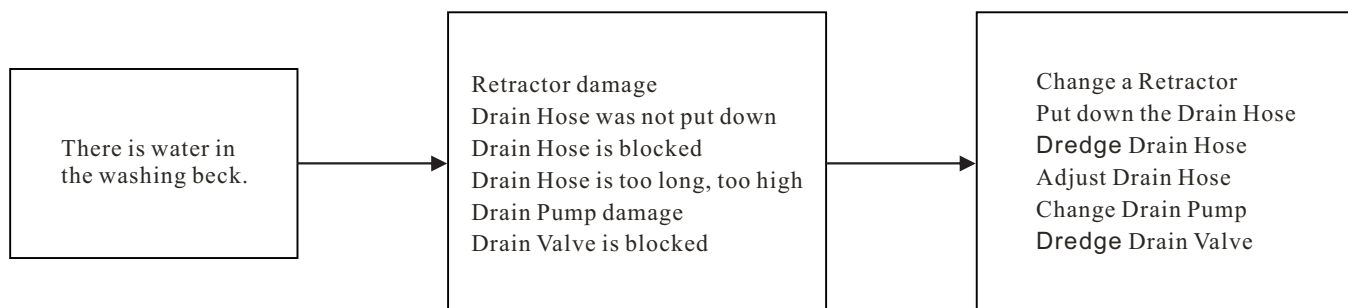

2.TROUBLESHOOTING

2.5 Abnormal Noise and Big Vibration

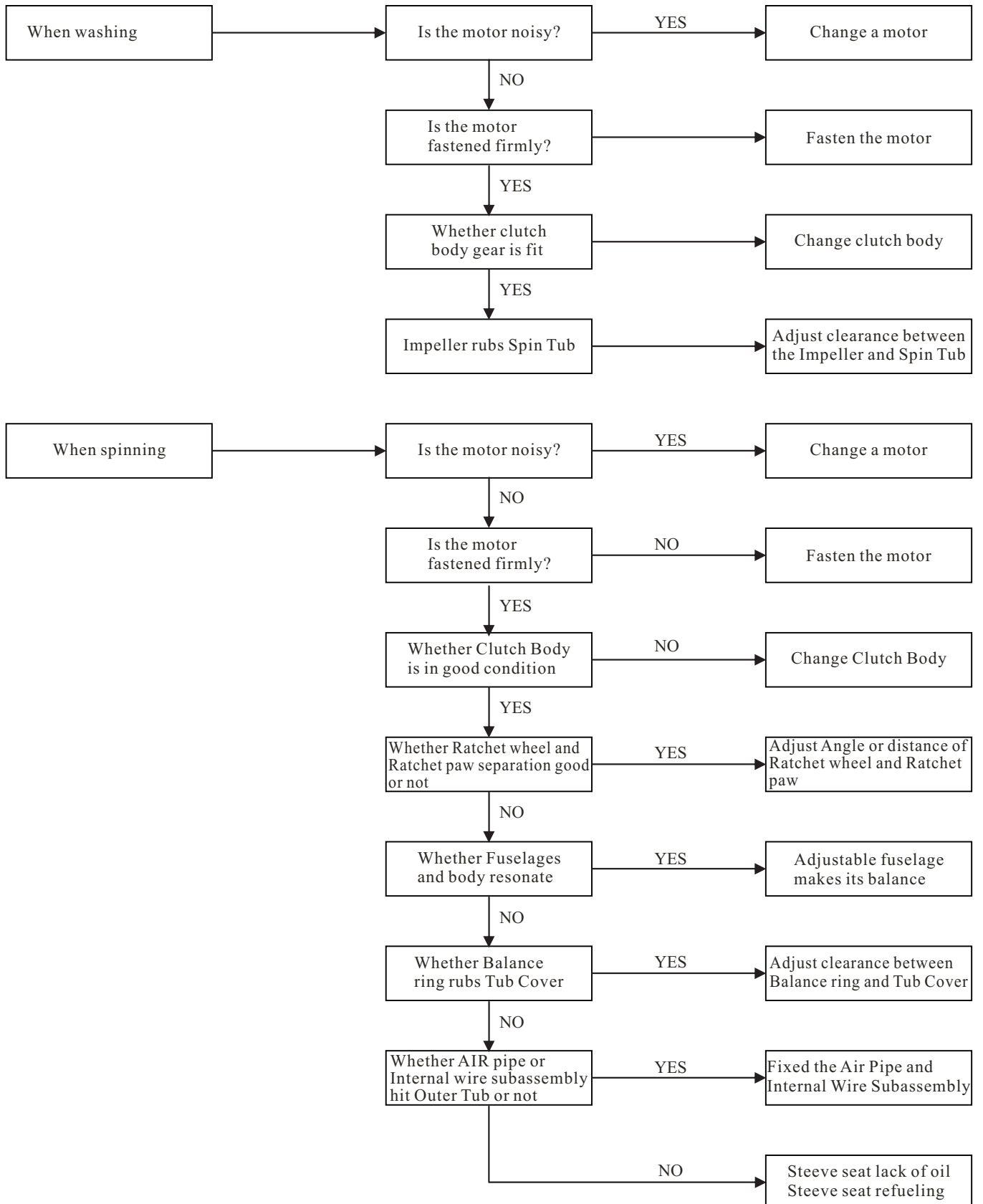

2.TROUBLESHOOTING

2.6 NO BILGING and BILGING INTERMITTENT

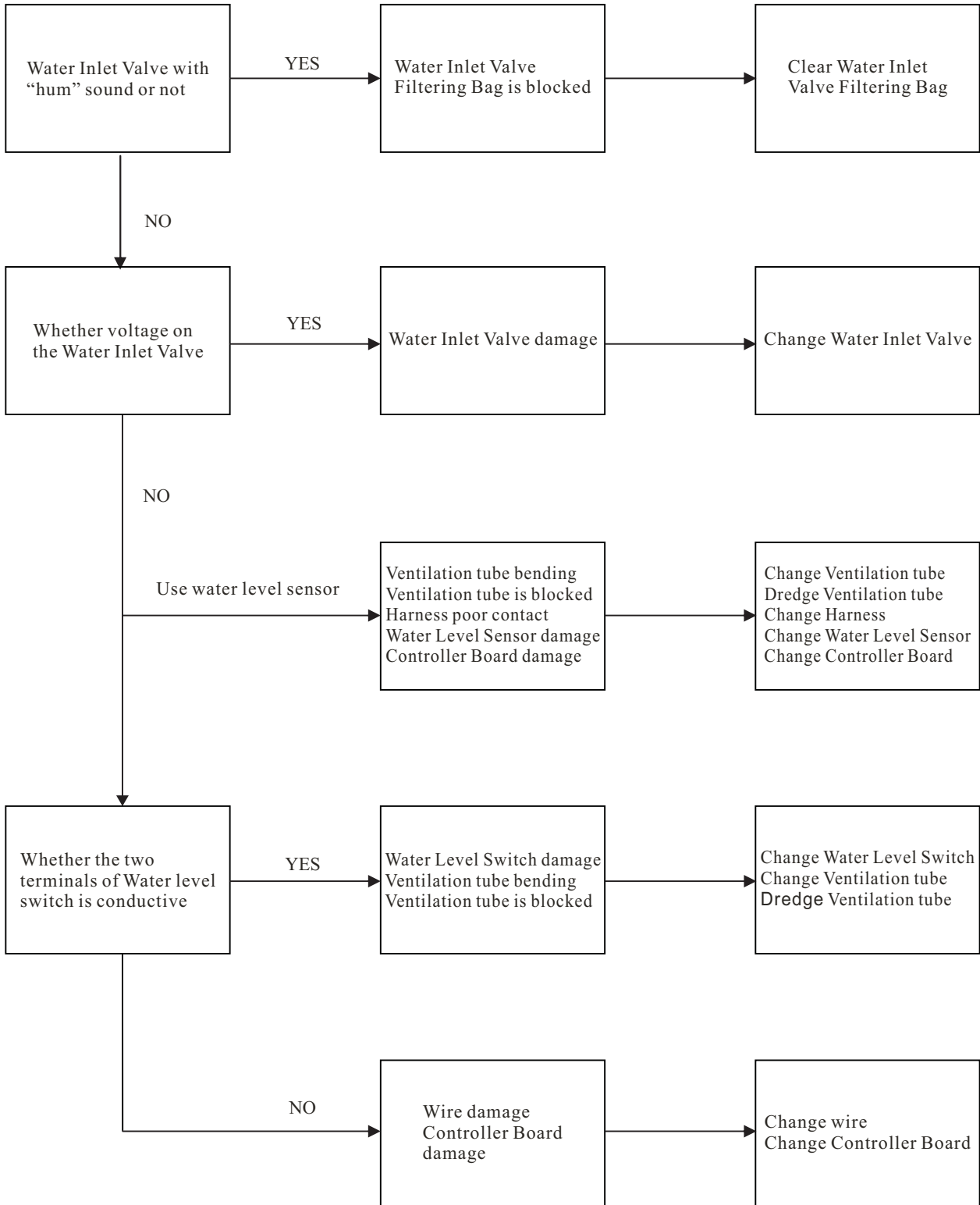

2.TROUBLESHOOTING

2.7 Water does not stop

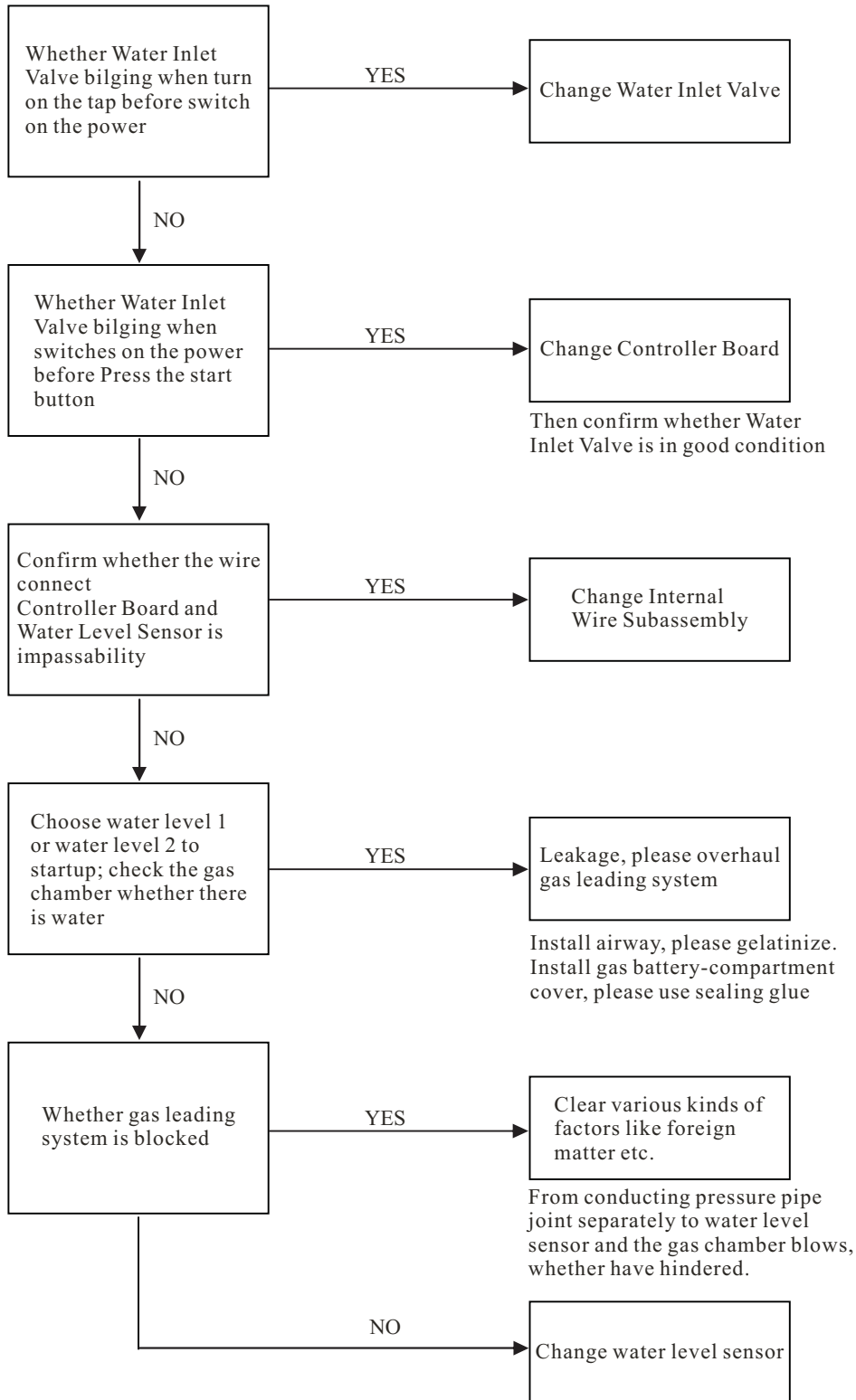

2.TROUBLESHOOTING

2.8 NO DRAINAGE

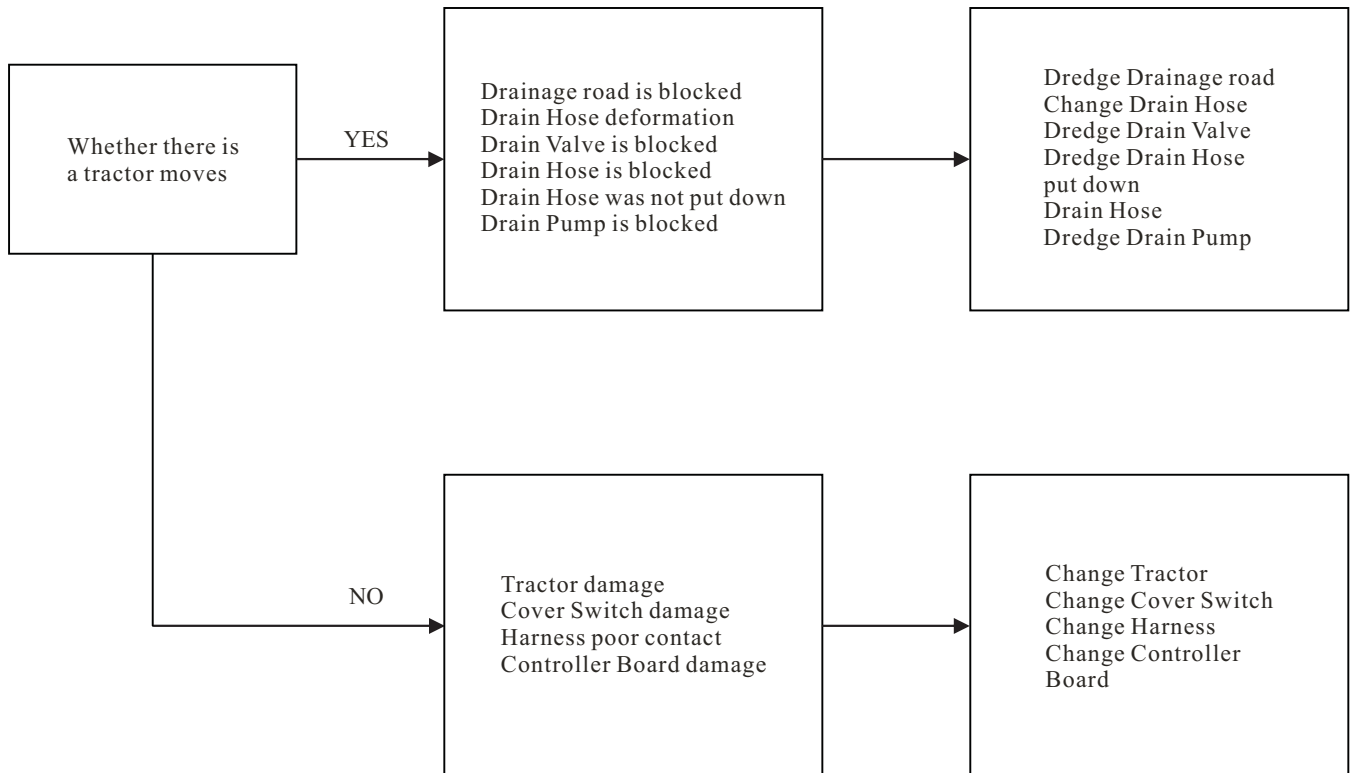

2.TROUBLESHOOTING

2.9 NO SPINNING

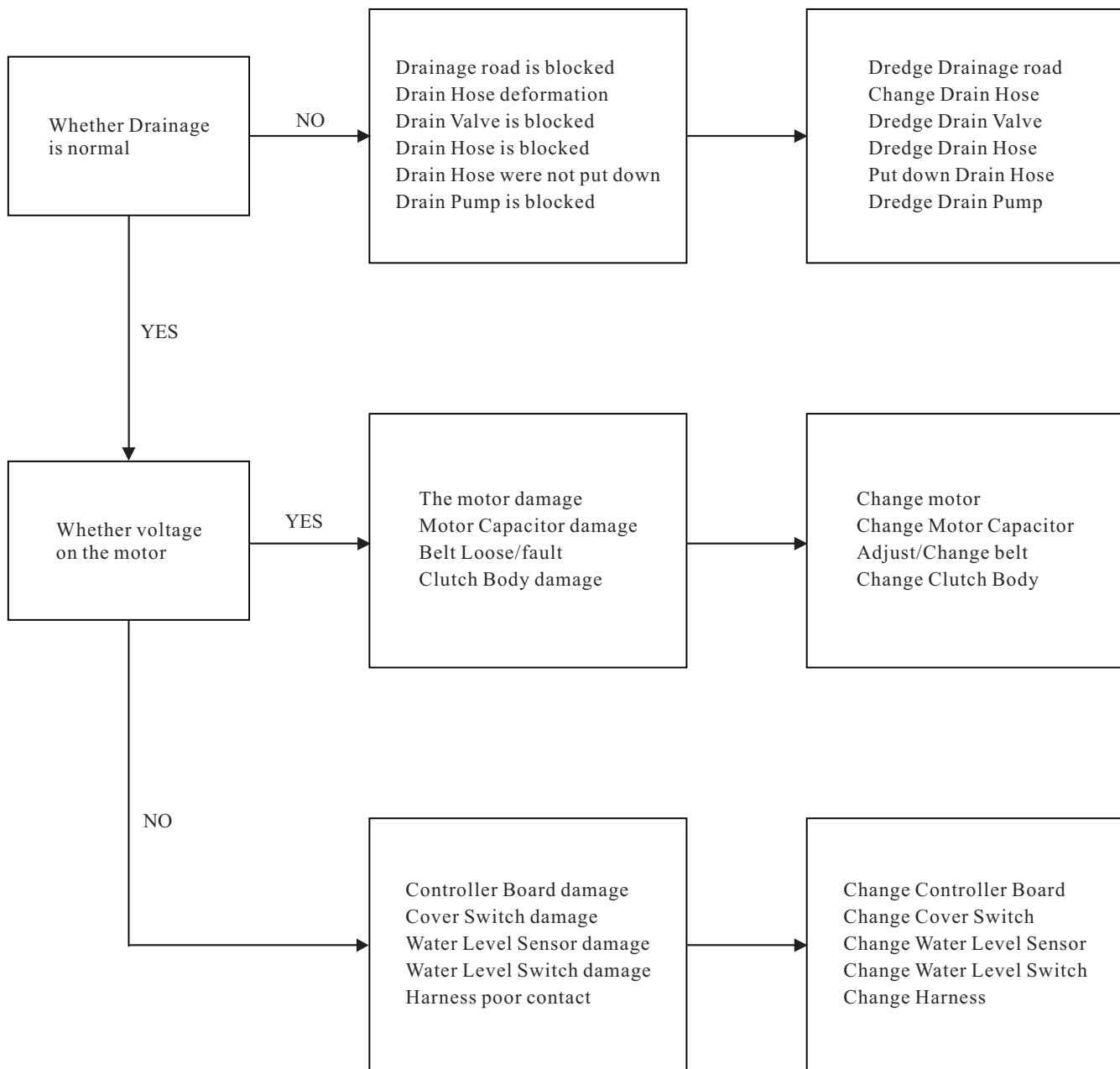

2.TROUBLESHOOTING

2.10 Leaking

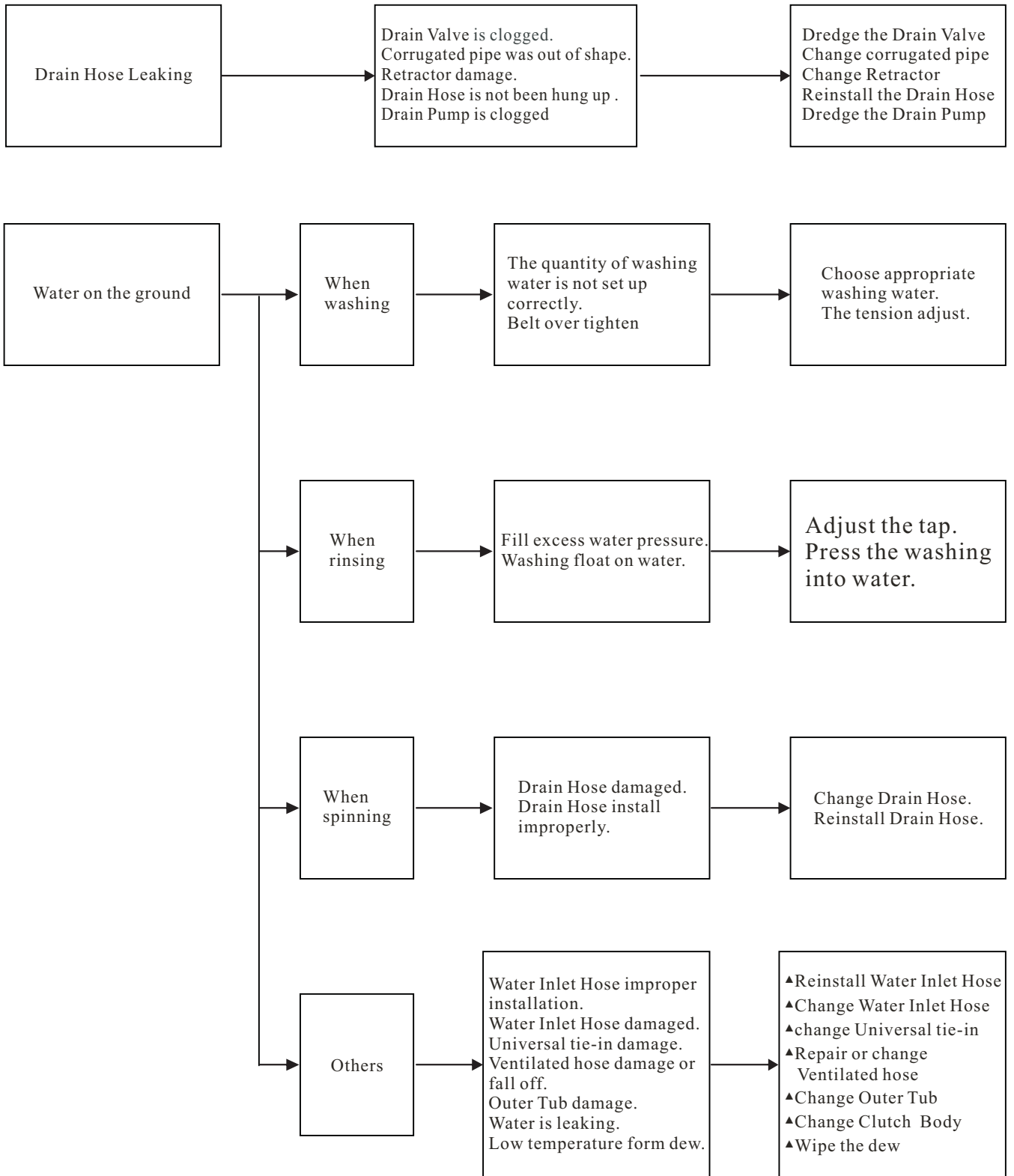

2.TROUBLESHOOTING

2.11 Oily shape dirt adherent

Common in use laundry powder

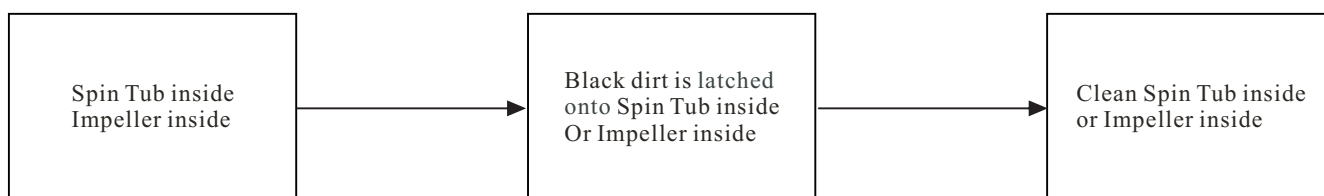

2.TROUBLESHOOTING

2.12 Anomaly alarm

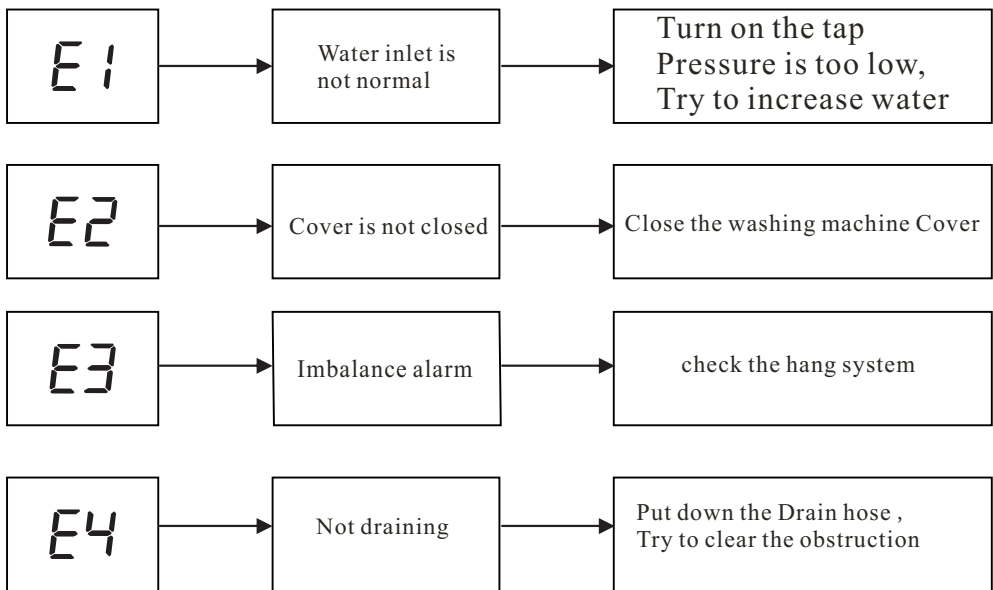

3.UNPACKING WAYS OF MAIN PARTS

3.1 Product disassembly precautions and steps:

1> General attention:



1. When you remove or repair, please you must unplug the power cord firstly
2. When you connect wire, you are sure to connect wire with wiring cap, use the tool to press wiring cap for connecting firmly and use tape to make the line insulation fully.
3. When you plug wire and connect wires, you must insert terminals to the roots for not easily pulling.
4. When you decorate internal wires, you fix internal wires to avoid encountering moving parts for example v-belt, pulley, suspend pole, etc or high temperature parts according to original state.
5. The removing screws must be preserved goodly, because you need screws to install.
6. When you diagnose faults, you are very careful to not get an electric shock if you need to operate in electricity situation.

2> Product disassembly steps:

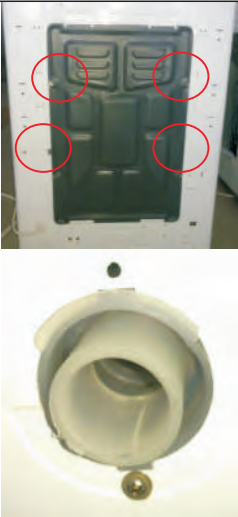

1. Remove the screws on the rear cover, remove the drain hose screws and then take down the rear cover.
2. Remove the earth screws, capacitor screws, and then pull out the air pipe.
3. Pull the insulating bag and then remove the wire connector.
4. Pull out the front control panel screws, and then remove the top cover screws.
5. Take down the top cover subassembly, and put it in the right place
6. Remove the controller board screws, pull out the controller board terminals, and then take down the controller board and the front control panel.
7. Take down the back control panel, cover switch, nozzle, water level sensor, and internal wire subassembly.
8. Take down cover pin, twist spring and take out cover subassembly..
9. Remove the outer tub cover screws and the impeller screws, finally take out the outer tub cover and the impeller.
10. Take out impeller adjusting washer, remove the big nut and take out the coupling flange washer.
11. Take out spin tub subassembly.
12. Take out the outer tub subassembly.
13. Turn the outer tub subordinate-subassembly, and remove the motor screws, the bracket screws, the clutch body subassembly screws, the retractor screws, and the drain pump screws (or drain valve subassembly screws), finally take out motor, bracket, clutch body subassembly, retractor, and drain pump (or drain valve subassembly).
14. Remove the base plate screws, and then take out outer tub subordinate-subassembly on the base plate
15. In turn counterclockwise (or clockwise) order take out the suspend poles, and then put them down on the ground.
16. Remove the power cord.
17. Remove the base subassembly for cabinet screws, and then take out the base subassembly for cabinet.

3.UNPACKING WAYS OF MAIN PARTS

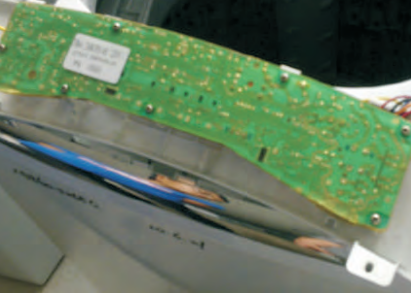

3> Product disassembly step-by-step instructions:

Product steps serial number	Product dissembling detailed steps	Picture caption
<p>1. Remove the screws on the rear cover, remove the drain hose screws and then take down the rear cover (make the drain hose and cabinet separate)</p>	<p>①Remove the screws on the rear cover (Red circle part) and then take out the rear cover.</p> <p>②Remove the drain hose screws to make the drain hose and cabinet separate</p>	
<p>2. Remove the earth screws, capacitor screws, and then pull out the air pipe. (make the air pipe and suspend poles separate)</p>	<p>①Remove the earth screws to make the earth wire subassembly and cabinet separate</p> <p>②Remove the capacitor screws, take down capacitor catch</p> <p>③Pull out the air pipe to make the air pipe and suspend poles separate (When you install the air pipe, you remember to coat adhesive for preventing leakage)</p>	
<p>3. Pull the insulating bag and then remove the wire connector.</p>	<p>①Pull the insulating bag</p> <p>②Remove the wire connector.</p>	

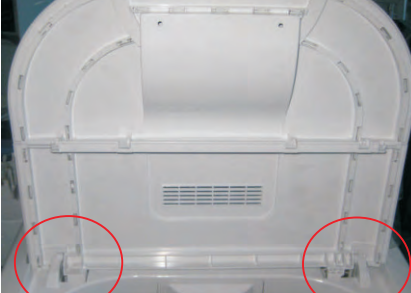
3.UNPACKING WAYS OF MAIN PARTS

<p>4. Pull out the front control panel screws, and then remove the top cover screws.</p>	<p>①Pull out the front control panel screws (sometimes need to remove the hole cover)</p> <p>②Remove the top cover front and back screws.</p>	
<p>5. Take down the top cover subassembly, and put it in the right place (avoid to scratch the top cover subassembly)</p>		
<p>6. Remove the controller board screws, pull out the controller board terminals, and then take down the controller board and the front control panel.</p>	<p>①Remove the controller board screws, pull out the controller board terminals(When you plug wire and connect wires, you must insert terminals to the roots for not easily pulling.)</p> <p>②Take down the controller board and the front control panel separately</p>	
<p>7. Take down the back control panel, cover switch, nozzle, water level sensor, and internal wire subassembly.</p>	<p>①Remove the back control panel screws, and take out the back control panel.</p> <p>②Remove the cover switch screws, and take out cover switch.</p> <p>③Take down the nozzle.</p> <p>④Remove the water level sensor screws, and take out the water level sensor.</p> <p>⑤Take out the internal wire subassembly.</p>	
<p>8. Take down cover pin, twist spring and take out cover subassembly</p>	<p>①Take down cover pin</p> <p>②Take down twist spring and take out cover subassembly.</p>	

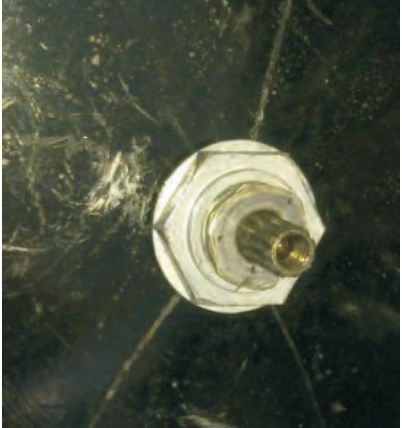
3.UNPACKING WAYS OF MAIN PARTS

<p>9. Remove the outer tub cover screws and the impeller screws , finally take out the outer tub cover and the impeller.</p>	<p>①Remove the outer tub cover screws, and take out the outer tub cover</p> <p>②Remove the impeller screws, and take out the impeller</p>	
<p>10. Take out impeller adjusting washer, remove the big nut and take out the coupling flange washer.</p>	<p>①Take out impeller adjusting washer</p> <p>②Remove the big nut and take out the coupling flange washer</p>	
<p>11. Take out spin tub subassembly.</p>	<p>①Take out spin tub subassembly, and put it on flat ground</p>	
<p>12. Take out the outer tub subassembly.</p>	<p>①Firstly make suspend poles and the outer tub subordinate-subassembly separately.</p>	

3.UNPACKING WAYS OF MAIN PARTS

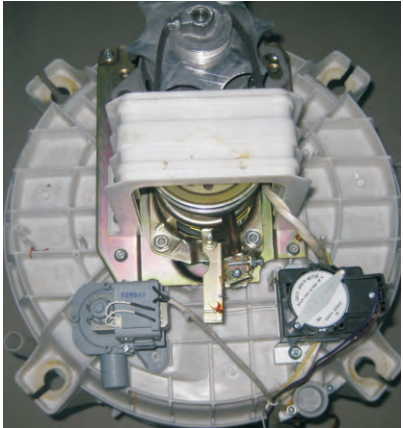
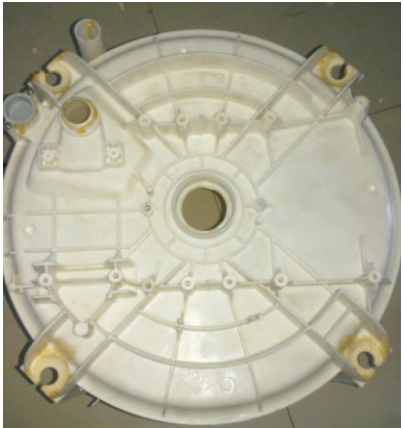
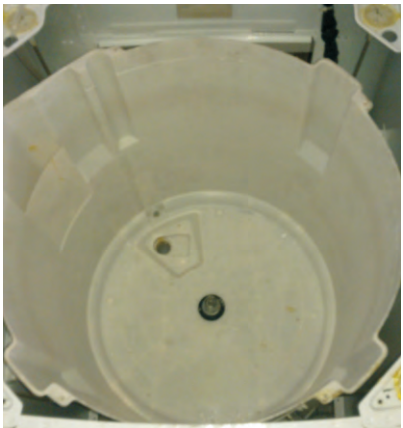
<p>13. Turn the outer tub subordinate -subassembly, and remove the motor screws, the bracket screws, the clutch body subassembly screws, the retractor screws, and the drain pump screws (or drain valve subassembly screws) , finally take out motor, bracket, clutch body subassembly, retractor, and drain pump (or drain valve subassembly)</p>	<p>①Remove the motor screws, and take out motor. ②Remove the bracket screws, and take out bracket. ③Remove the clutch body subassembly screws, and take out clutch body subassembly. ④Firstly make retractor and the clutch body subassembly separately., remove retractor screws, and take out retractor</p>	
	<p>⑤Remove drain pump screws (or drain valve subassembly screws) , and take out drain pump (or drain valve subassembly) , (When you install drain pump (or drain valve subassembly) , you remember to coat adhesive for preventing leakage)</p>	
<p>14. Remove the base plate screws, and then take out outer tub subordinate -subassembly on the base plate</p>	<p>①Remove the base plate screws, and take out the base plate. ②Take out outer tub subordinate -subassembly on the base plate.</p>	
<p>15. In turn counterclockwise (or clockwise) order take out the suspend poles, and then put them down on the ground.</p>	<p>①When you install the suspend poles, you remember the installing order.</p>	
<p>16. Remove the power cord</p>	<p>①Remove the power cord</p>	

3.UNPACKING WAYS OF MAIN PARTS

17. Remove the base subassembly for cabinet screws, and then take out the base subassembly for cabinet.

①Remove the base subassembly for cabinet screws, and then take out the base subassembly for cabinet.

②Take out the cabinet.



4.CIRCUIT DIAGRAM

4.1 The electrical principle picture

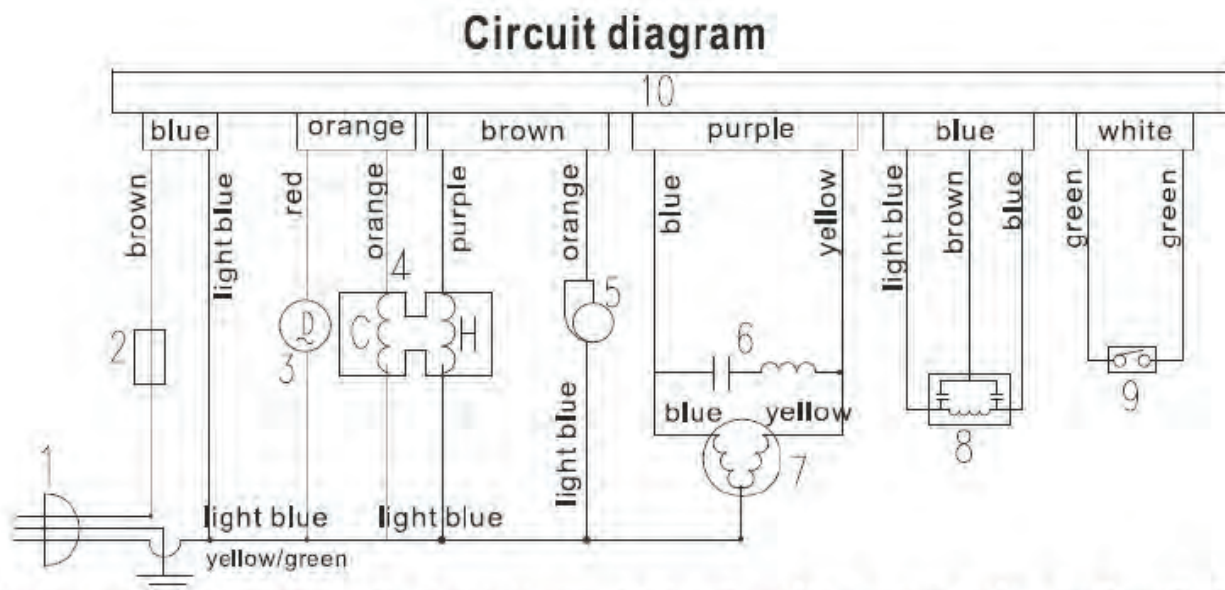

- 1. Power cord 2. Fuse 3. Retractor 4. Hot & cold water inlet valve 5. Pump 6. Capacitor & inductance assembly 7. Motor 8. Water level sensor 9. Linked switch 10. Electronic controller**