



SERVICE MANUAL

TWIN TUB WASHING MACHINE

PWM6010M

PWM8010PM











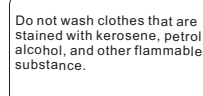
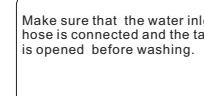
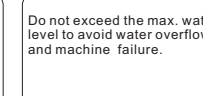

PWM1010PM

PWM1210PM

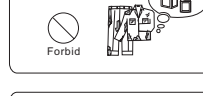
TABLE OF CONTENTES

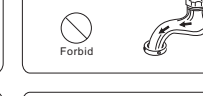
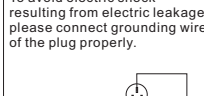
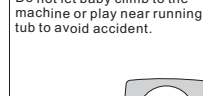
1. Safety precaution	2
2. Introduction of product	3
2.1 Name of parts	3
3. Trouble shooting	4
3.1 Malfunction and solution	4
3.11. Unusual sound when washing or wash weakly (motor with sound)	4
3.12. Can not wash (motor does not rotate)	4
3.13. Electric leakage	4
3.14. Spin tub can not rotate	5
3.15. Start of spin is too long; spin tub bump with outer tub when running	5
3.16. Unusual sound when spinning	5
3.17. Unusual sound when pulsator rotates	6
3.18. No drain or unsmooth drain	6
3.19. Poor brake of spin tub	7
3.110. Water leakage from the side of wash tub	7
3.111. Water leakage from the side of spin tub	7
3.2 Fault tree	8
3.21. Can not wash (motor does not rotate)	8
3.22. Spin tub can not rotate	9
3.23. No drain or unsmooth drain	10
4. Dismantling ways of main parts	11
4.1. Remove the knobs	11
4.2. Remove the control panel	11
4.3. Remove the spin cover	11
4.4. Remove the pulsator	12
4.5. Remove the lint filter	12
4.6. Remove the frame	12
4.7. Remove the spin tub	13
4.8. Remove the base	13
4.9. Remove the motor pulley	13
4.10. Remove the capacitor	14
4.11. Remove the brake wheel	14
5. Electronic components	15
5.1. Self-test method of wash timer	15
5.2. Self-test method of spin timer	15
5.3. Self-test method of wash-drain selection switch	15
5.4. Self-test method of safety switch	16
5.5. Self-test method of capacitor	16
5.6. Self-test method of motor	16
6. Circuit diagram	18
7. Explored view & list of parts	19

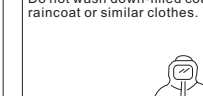
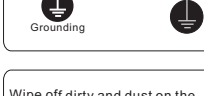
1. SAFETY PRECAUTION

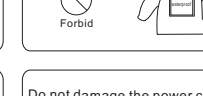
<p>Do not dismantle the machine by yourself.</p> 	<p>Do not install the machine in damp or rainy environment to avoid electric shock, fire, machine failure, or deformation.</p> 	<p>Do not place inflammable materials like burning candle, mosquito incense, cigaret etc. or heating source like electric stove, calorifier etc. on the machine.</p> 	<p>Do not spray water directly to the machine.</p> 
<p>Do not let baby sit on it or place heavy things on it.</p> 	<p>Do not wash clothes that are stained with kerosene, petrol, alcohol, and other flammable substance.</p> 	<p>Make sure that the water inlet hose is connected and the tap is opened before washing.</p> 	<p>Do not exceed the max. water level to avoid water overflowing and machine failure.</p> 
<p>To avoid electric shock resulting from electric leakage, please connect grounding wire of the plug properly.</p> 	<p>Do not let baby climb to the machine or play near running tub to avoid accident.</p> 	<p>If use warm water, the water temperature should not exceed 50°C.</p> 	<p>Do not wash down-filled coat, raincoat or similar clothes.</p> 
<p>Wipe off dirty and dust on the plug often to prevent poor contact with power supply.</p> 	<p>Do not put hands into the tub before it stopping running.</p> 	<p>Do not replace power cord by yourself.</p> 	<p>Do not damage the power cord and plug to avoid electric shock, short circuit or fire.</p> 
<p>Insert the plug tightly when use.</p> 	<p>Do not pull the cord when unplug the plug.</p> 	<p>Do not insert or unplug the plug with wet hands to avoid electric shock.</p> 	<p>Unplug the plug from socket after use.</p> 

2. INTRODUCTION OF PRODUCTS

2.1 Name of parts

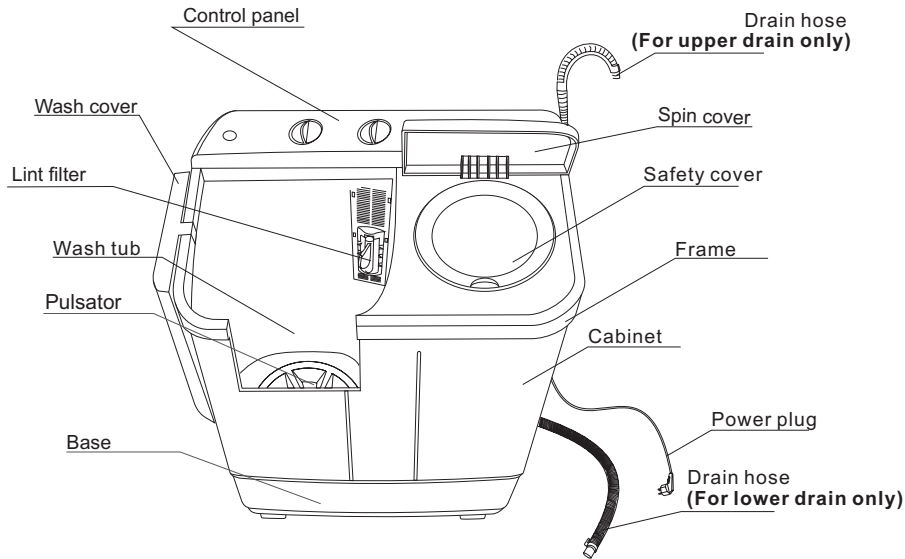

*The drawing above is based on the actual washer.

3. TROUBLE SHOOTING

3.1 Malfunction and solution

Symptom	Possible reason	Solution
1. Unusual sound when washing or wash weakly (motor with sound)	<ul style="list-style-type: none"> a. Laundry is much more than rated washing capacity. b. Pulsator is tangled with clothes or blocked by things like coins. c. V-belt loose, broken or fall from the strap wheel. d. Pulley broken or pulley screw is loose. e. Capacitor failure. f. Wash-drain selection switch does not work. 	<ul style="list-style-type: none"> a. Reduce the laundry till the pulsator can rotate normally. b. Take off plug, remove the tangled clothes or other things. c. Replace v-belt or reload the v-belt. d. Replace the pulley or tight the pulley locking screw. e. Replace the capacitor. f. Replace the switch.
2. Can not wash (motor does not rotate)	<ul style="list-style-type: none"> a. Power supply is cut off or poor contact of plug and socket. b. Voltage is too low. c. Wash timer is in poor contact or faulted. d. Fuse is burned. e. Wash motor failure. 	<ul style="list-style-type: none"> a. Check the power supply and adjust the plug to insure good contact. b. Do not use the washing machine until the voltage rise to rated voltage. c. Check the wire harness or replace the wash timer. d. Replace the fuse. e. Replace the wash motor.
3. Electric leakage	<ul style="list-style-type: none"> a. Conductive wire or alive parts in the machine contacts with metal cabinet. b. Bad grounding wire. c. 2 power lines of the power supply. d. Weak insulation strength of motor. e. Insulation layer of wire harness is broken. 	<ul style="list-style-type: none"> a. Check wire connecting in the machine. b. Check the grounding wire. c. Examine and replace the power supply. d. Replace the motor. e. Examine the wire harness and bind up the broken wire.

3.TROUBLE SHOOTING

Symptom	Possible reason	Solution
4. Spin tub can not rotate	<ul style="list-style-type: none"> a. Spin motor winding is burned. b. Fuse is burned. c. Spin timer does not work. d. Capacitor failure. e. Cable joint is loosened. 	<ul style="list-style-type: none"> a. If the motor is damaged because of water leakage from spin tub, check the reason of leakage and solve the problem. b. Replace the fuse. c. Replace the spin timer. d. Replace the capacitor. e. Join the cable with a pair of plier.
5. Start of spin is too long; spin tub bump with outer tub when running	<ul style="list-style-type: none"> a. Clothes in spin tub is placed uneven. b. Laundry is much more than rated load. c. Drain hose is not placed properly or too much water stored in the spin tub. d. The pull-in torque of spin motor is low. e. The capacity of capacitor is low. f. The brake plate is too near to the connector. 	<ul style="list-style-type: none"> a. Make the clothes even. b. Reduce the load. c. Place the drain hose properly and do not use it until water in spin tub is drained completely. d. Replace the spin motor. e. Replace the capacitor. f. Adjust the position of brake belt and belt hanging hole to keep a proper space between the brake plate and the connector.
6. Unusual sound when spinning	<ul style="list-style-type: none"> a. There is a lack of oil for oil-retaining bearing of the spin tub rotating shaft. b. External things, like socks exist between spin tub and wash tub. c. The machine is not placed even or laundry is not placed even. d. Unusual sound from the spin motor. e. The brake plate is too near to the connector. 	<ul style="list-style-type: none"> a. Lubricate the oil-retaining bearing. b. Take off the spin tub and remove the extra things. c. Place the machine on flat ground and adjust the laundry. d. Replace the spin motor. e. Adjust the position of brake belt and belt hanging hole to keep a proper space between the brake plate and the connector.

3.TROUBLE SHOOTING

Symptom	Possible reason	Solution
7. Unusual sound when pulsator rotates	<ul style="list-style-type: none"> a. There is things like coins, buttons under the pulsator. b. The fixing screw become loose and the pulsator vibrates. c. Gear in the retarder is damaged. d. Anti-loose nuts on the big pulley become loose, so the wheel jumps and make unusual noise. e. The v-belt is not smooth and makes noise when running on the pulley. f. The motor pulley and the big pulley is not at a level. g. Noise inside the wash motor. 	<ul style="list-style-type: none"> a. Dismantle the pulsator and take out the things. b. Tighten the fixing screw. c. Replace the retarder. d. Screw tight the anti-loose nuts. e. Replace the v-belt. f. Adjust the motor pulley to make it at the same level with the big pulley. g. Replace the wash motor.
8. No drain or unsmooth drain	<ul style="list-style-type: none"> a. When draining, the hose is not put down and the water can not be drained.(for lower drain function only) b. Wash -drain selection switch is not in "drain" position. c. Drain outlet is not laid properly. (for upper drain function only) d. Drain pump failure (for upper drain function only). e. Drain outlet is blocked at the side of wash tub. f. Drain belt falls from the switch. g. Drain belt is loosened or broken. 	<ul style="list-style-type: none"> a. Put down the drain hose and make the hose mouth to the sewer. b. Turn the switch to "drain" position c. The drain hose should be placed 86 cm-100cm from the bottom of the ground. d. Replace the pump or open the valve cover to clear up the pump. e. Dismantle the pulsator and take out the blocks at the drain outlet. f. Connect the drain belt with the switch. g. Replace the drain belt.

3.TROUBLE SHOOTING

Symptom	Possible reason	Solution
9. Poor brake of spin tub	<ul style="list-style-type: none"> a. Safety switch contact does not open when open the spin cover. b. The tightwire kit becomes loose. c. Brake plate is badly worn. d. Brake belt is too tight. 	<ul style="list-style-type: none"> a. Adjust the safety switch contact. b. Reload the brake belt or brake steel wire. c. Replace the brake plate. d. Adjust the position of drain belt and brake belt hanging hole to keep a proper space between the brake plate and coupler.
10. Water leakage from the side of washing tub	<ul style="list-style-type: none"> a. Wash tub leaks. b. Seal ring of the retarder leaks. c. The overflow hose brakes and water leaks from the broken place. d. Drain valve core brakes and water leaks from the valve cover. e. Drain hose joint is badly bound and water leaks from the joint place. 	<ul style="list-style-type: none"> a. Replace the wash tub. b. Replace the seal ring of the retarder. c. Replace the overflow hose. d. Replace the drain valve core. e. Dismantle drain hose joint and stick them again.
11. Water leakage from the side of spin tub	<ul style="list-style-type: none"> a. The rubber damper is not properly fixed and water leaks from the brim of rubber damper. b. Spin seal broken and water leaks from the broken place. c. The diameter of spin shaft becomes smaller because abrasion. 	<ul style="list-style-type: none"> a. Replace the rubber damper. b. Replace the spin seal. c. Replace the spin tub.

3.TROUBLE SHOOTING

3.2 Fault tree

1. Can not wash (motor does not rotate)

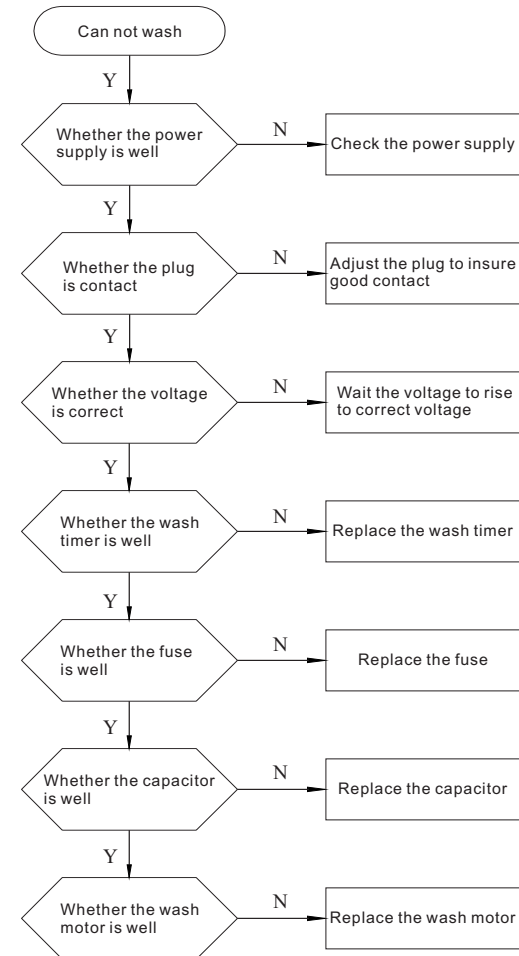

3.TROUBLE SHOOTING

2. Spin tub can not rotate

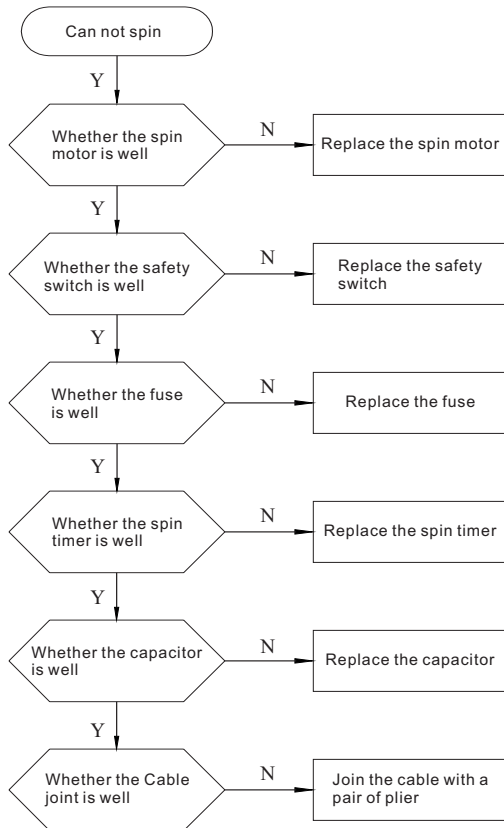





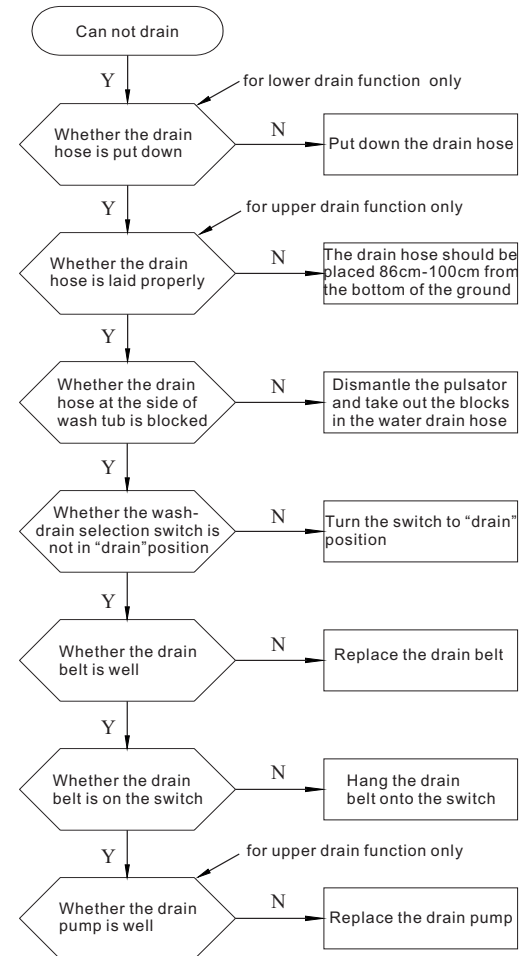



3.TROUBLE SHOOTING



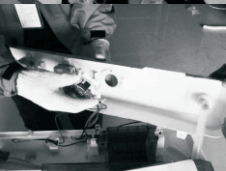



3. No drain or unsmooth drain







4. DISMANTLING WAYS OF MAIN PARTS

Operation step	Picture
<p>1. Remove the knobs</p> <p>a. Take out the knobs directly because knobs are inserted into the control panel.</p> <p>b. If it is difficult to take knobs out, a straight screwdriver wrapped with cloth can be used for help.</p>	<p>a. </p> <p>b. </p>
<p>2. Remove the control panel</p> <p>a. Take down the back cover by loosening off the screws.</p> <p>b. Take down the bag by cutting off the nylon clip. Take down all wire nut with a plier and make all wire clamps loose. And then unfasten the drain belt connector.</p> <p>c. Unfasten the screws on the control panel.</p> <p>d. The control panel can be lifted and removed.</p>	<p>a. </p> <p>b. </p> <p>c. </p> <p>d. </p>
<p>3. Remove the spin cover</p> <p>a. Open the spin tub cover. Loosen the connector of the brake belt.</p> <p>b. Keep the spin tub cover open and remove the hinge spring.</p> <p>c. The spin cover can be drawn out by swinging.</p>	<p>a. </p> <p>b. </p> <p>c. </p>

4. DISMANTLING WAYS OF MAIN PARTS

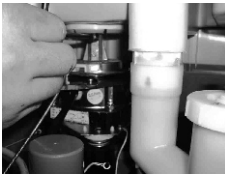
Operation step	Picture
<p>4. Remove the pulsator</p> <p>a. Unscrew the pulsator screw.</p> <p>b. Draw out the pulsator with hands.</p>	<p>a. </p> <p>b. </p>
<p>5. Remove the lint filter</p> <p>a. Press the lint filter subassembly then pull it out.</p>	<p>a. </p>
<p>6. Remove the frame</p> <p>a. Screw off fixing screws of the frame.</p> <p>b. Screw off screws under the handles at both sides of the frame.</p> <p>c. Screw off the stainless steel screw on the top surface of the frame.</p> <p>d. The frame can be removed.</p>	<p>a. </p> <p>b. </p> <p>c. </p> <p>d. </p>

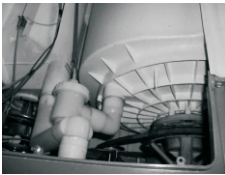
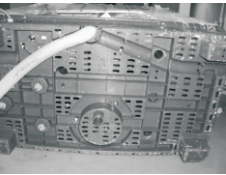

4.DISMANTLING WAYS OF MAIN PARTS

Operation step	Picture
<p>7.Remove the spin tub</p> <p>a. Unscrew the fixing screw under the tub with a socket wrench.</p> <p>b. The spin tub can be removed then.</p>	<p>a. </p> <p>b. </p>
<p>8. Remove the base</p> <p>a. Press the V-belt at the part near the pulley. Then take down the V-belt by rotating the pulley.</p> <p>b. Spread one blanket on the floor then lay down the washing machine. Pull out the drain hose from the clamp and draw out the drain hose subassembly. After screws on the base are unscrewed, the base assembly can be disassembled.</p>	<p>a. </p> <p>b. </p>
<p>9. Remove the motor pulley</p> <p>a. Loosen the nut with special wrench, then loosen the screw.</p>	<p>a. </p>

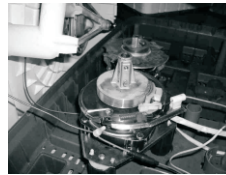
4.DISMANTLING WAYS OF MAIN PARTS

Operation step	Picture
<p>10. Remove the capacitor</p> <p>a. Hold firm the capacitor then pull it out.</p>	<p>a. </p>
<p>11. Remove the brake wheel</p> <p>a. Loose the fixing screw then draw the brake wheel out.</p>	<p>a. </p>

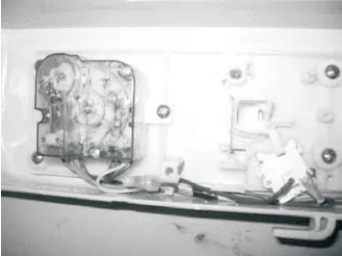
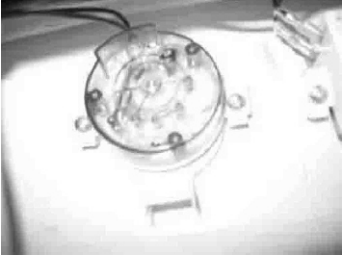
5.ELECTRONIC COMPONENTS

Operation step	Picture
<p>1. Self-test method of wash timer</p> <p>Turn the wash timer to work condition. Use a multimeter to measure the connection and disconnection condition of input terminal (brown wire) and output terminal (yellow or orange wire), and the wash timer should be regular on-off.</p>	
<p>2. Self-test method of spin timer</p> <p>Use a multimeter to test the two conducting wire. If the spin timer is in working condition, the two wire should be conductive.</p>	
<p>3. Self-test method of wash-drain selection switch</p> <p>Use a multimeter to measure the selection switch, the switch should be regular on-off.</p>	

5.ELECTRONIC COMPONENTS

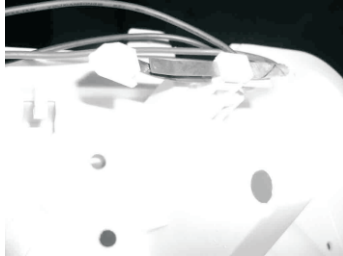
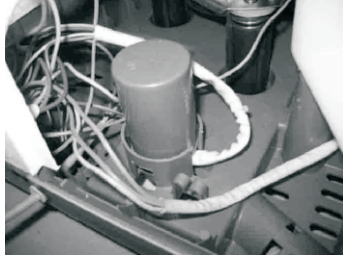
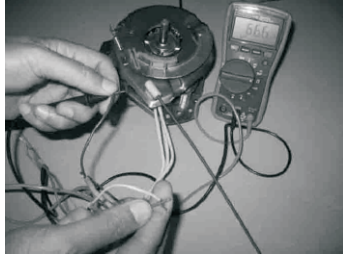
Operation step	Picture
<p>4. Self-test method of safety switch</p> <p>The safety switch should be in closure state when the spin tub cover is closed.</p>	
<p>5. Self-test method of capacitor</p> <p>Use an analog multimeter to measure capacitance by connecting the two ends of capacitor with the multimeter rod connector. If the pointer swing to the direction of smaller resistance, and then turn back to the direction of "0" slowly, it means that the capacitor is ok. If not, it means that the capacitor is faulted.</p>	
<p>6. Self-test method of motor</p> <p>a. To check whether the motor insulation is damaged by water leakage: Use a 500 V megohmmeter to measure whether the insulation resistance of motor is higher than 30MΩ. At the same time, check whether the other resistance of the motor are normal. If the other resistance are abnormal (any short-circuit, open circuit appears), the motor can not be used. Only the two items are normal, the motor can be used.</p>	

5.ELECTRONIC COMPONENTS

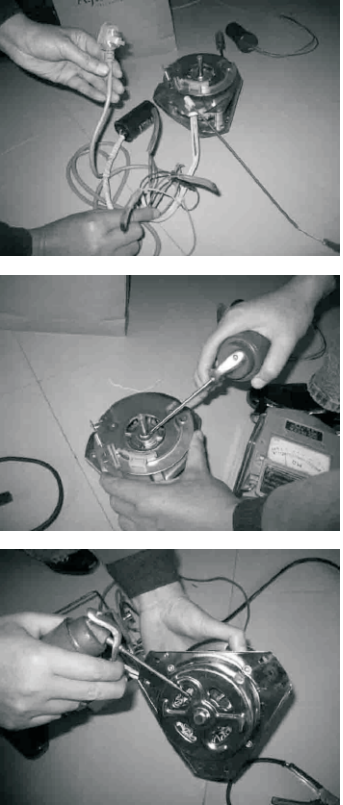
Operation step	Picture
<p>b. Check whether the motor resistance is normal in the condition of no water condition:</p> <p>Use a multimeter to measure the resistance of the three leads, and name them R1, R2, R3. Only the "R1+R2=R3" indicates that the motor resistance is normal.</p>	
<p>c. Check the motor operation condition:</p> <p>Use power cable with fuse to connect the motor and capacitor correctly, and do the preparation for insulation. For the motor under use, add certain 20# machine oil on the upper and down bearing to eliminate the negative effect arising from water leakage. After powering on the two components, there should be no obvious noise, vibration, or odor of the motor.</p>	

6.CIRCUIT DIAGRAM

